

# SL906DLTM100

1000MM ONBOARD TWIN MOTOR UNDER-MOUNT



## SPECIFICATIONS

<b>Rangehood Type</b>	Undermount
<b>GTIN</b>	9351116005092
<b>Country of Origin</b>	Handcrafted in Italy
<b>Designed to Suit</b>	600-1000mm GAS or INDUCTION
<b>Controls</b>	Buttons
<b>Speed Settings</b>	4
<b>Ducting Diameter</b>	200mm
<b>Recirculating</b>	No
<b>Extraction Type</b>	Onboard Motor
<b>Motor</b>	Green Energy Twin Aluminium Motor
<b>Extraction Rate</b>	2000m <sup>3</sup> /hr
<b>Filter Type</b>	2 x 25mm Stainless Steel Baffle
<b>Noise Level</b>	45dBa(min) to 70dBa(max)
<b>Lighting</b>	2 x 3.75W Dimmable And Dynamic Led Strip
<b>Run-on Timer</b>	10 Minutes
<b>Electrical Requirement</b>	10A
<b>Max Current (W)</b>	548W
<b>Product Dimensions (mm)</b>	W1000 x D290 x H350
<b>Cut-Out Dimensions (mm)</b>	W985 x D265
<b>Weight</b>	35kg
<b>Warranty</b>	3 Years (6 years when Sirius ducting is used)

## LINE DRAWING

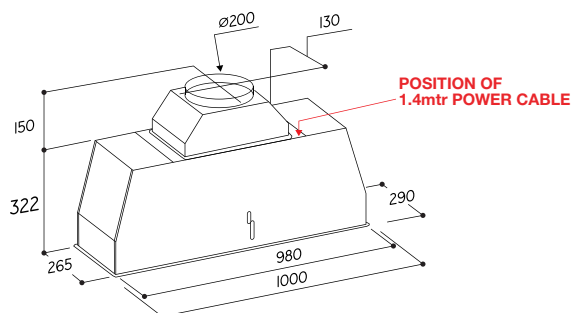

## KEY FEATURES



### Green Energy Twin Aluminium Motor

Perfect for large and open kitchens, Sirius twin motor hoods boast powerful 2000M<sup>3</sup>/H extraction to efficiently remove steam, heat, smoke, and odours. With four speeds options for tailored ventilation.



### Slimline Installation

Slim design fits seamlessly into minimalist kitchens. Strong extraction power and modern design ideal for luxurious kitchen setups.



### 25mm Stainless Steel Baffle Filters

Baffle filters feature interlocking baffles for effective grease removal, promoting smooth airflow. They're easy to maintain, offer superior filtration with a deep pleat design, and dishwasher safe.



### Powerful Extraction

With a twin motor this rangehood's impressive maximum airflow of 1930M<sup>3</sup>/H, quickly and effectively removes smoke, steam, heat, odours, and other airborne particles from the kitchen.



### Induction Safe

This rangehood boasts efficient filters and extraction capabilities to effectively manage increased steam and moisture levels resulting from minimal ambient heat compared to gas cooking methods.



### Dynamic Lighting

Sirius Rangehoods have a dynamic lighting system that can be adjusted from 2700 to 6500 kelvin to match other lighting in the room. Adjustable temperature, and dimmable. Maximum design flexibility.



### Hand Crafted In Italy

Sirius Rangehoods, a prestigious Italian brand founded in 1996, is renowned for its bold designs and commitment to premium materials and craftsmanship, making it a top choice for high-end rangehoods.



### 4 Speed settings

Sirius Rangehoods offer 4 speed settings. Levels 1 to 3 for light to normal cooking and level 4 for smoky or intense cooking. Covering all your cooking needs.

DISTRIBUTED BY ARISIT PTY LTD

40-50 Mark Anthony Drive, Dandenong South VIC 3175  
Ph: 1300 762 219 Fax: 03 9768 0838 Website: www.arisit.com