

SL906EMEL100

1000MM OFFBOARD UNDERMOUNT



SPECIFICATIONS

Rangehood Type	Undermount
GTIN	9351116005047
Country of Origin	Handcrafted in Italy
Designed to Suit	600-1000mm GAS or INDUCTION
Controls	Buttons, APP & Voice Controls
Speed Settings	4
Ducting Diameter	150mm
Recirculating	No
Extraction Type	Offboard Motor
Motor Options	SEM 11, SEM 21, SEM 51
Extraction Rate	1200m ³ /hr
Filter Type	25mm Stainless Steel Baffle
Noise Level	Depends on motor / installation
Lighting	2 x 3.75W Dimmable And Dynamic Led Bar
Run-on Timer	Custom
Electrical Requirement	10A
Max Current (W)	508W
Product Dimensions (mm)	W1000 x D290 x H350
Cut-Out Dimensions (mm)	W980 x D265
Weight	20kg
Warranty	3 Years (6 years when Sirius ducting is used)

LINE DRAWING

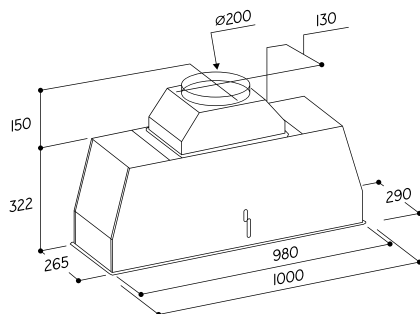

KEY FEATURES



Offboard Green Energy Motor

Power, performance and quiet efficiency are the most important elements in the performance of your Sirius hood. Sirius has worked tirelessly to create a product that ticks all the boxes.



25mm Stainless Steel Baffle Filters

Baffle filters feature interlocking baffles for effective grease removal, promoting smooth airflow. They're easy to maintain, offer superior filtration with a deep pleat design, and dishwasher safe.



Powerful Extraction

Sirius offers powerful rangehoods, providing superior extraction for all cooking styles. With revolutionary technology and advanced engineering, they're ideal for any kitchen.



Induction Safe

This rangehood boasts efficient filters and extraction capabilities to effectively manage increased steam and moisture levels resulting from minimal ambient heat compared to gas cooking methods.



App Control

Rangehood compatible with Sirius app for mobile control via Wi-Fi. Download from Apple App or Google Play store. Adjust lighting, fan speed, and receive filter cleaning alerts.



Slimline Installation

Slim design fits seamlessly into minimalist kitchens. Strong extraction power and modern design ideal for luxurious kitchen setups.



Dynamic Lighting

Sirius Rangehoods have a dynamic lighting system that can be adjusted from 2700 to 6500 kelvin to match other lighting in the room. Adjustable temperature, and dimmable. Maximum design flexibility.



Hand Crafted in Italy

Sirius Rangehoods, a prestigious Italian brand founded in 1996, is renowned for its bold designs and commitment to premium materials and craftsmanship, making it a top choice for high-end rangehoods.

DISTRIBUTED BY ARISIT PTY LTD

40-50 Mark Anthony Drive, Dandenong South VIC 3175
Ph: 1300 762 219 Fax: 03 9768 0838 Website: www.arisit.com