



valentina
collection



Sirius

**Congratulations on your purchase!
Thank you for choosing a Sirius product.**



User manual for 'The Kite' and 'The Line' Rangehoods

INSTALLATION AND USE INSTRUCTIONS

'The Kite' SLT977EMEL
'The Line' SLT978EMELBK

EAN #9351116003050
EAN #9351116001353

BEFORE YOU INSTALL	4
TO THE ATTENTION OF THE USER	5
PRE-INSTALLATION CHECKS	6
BEFORE YOU INSTALL	7
ATTACHING THE PENDANT LIGHT	8
LINE MEASUREMENTS	9
INSTALLING THE TIMBER SUPPORT BEAMS	10
MOTOR AND VENTING OPTIONS	11
TOP VENT INSTALLATION	12
SIDE VENT INSTALLATION	
SEM11 & SEM 21	13
DUCTING FROM MOTOR TO WALL	14
ELECTRICAL CONNECTION	15
REMOTE CONTROL	16
OPERATION	17
THE SIRIUS APP	18
PARTS LIST	26
OPTIONAL PARTS LIST	27
WIRING DIAGRAMS	28
WARRANTY	29

BEFORE YOU INSTALL - DUCTING INFORMATION

Sirius warranty covers only Sirius product. If you choose to install a non-Sirius branded accessory such as flexible ducting, Sirius will only warrant the rangehood and motor. If installation is found to be the cause of failure or issue then charges will apply for service and parts.

Flexible ducting is not permitted under any circumstances. Flexible ducting has been found to increase noise levels, increase vibration and reduce airflow. Sirius Semi-rigid or solid ducting can be used in lieu. There is a range available to suit any application.



The appliance must be installed and connected to the power supply only by a qualified technician.

- There should be adequate ventilation of the room when the rangehood is used at the same time as appliances burning gas or other fuels (not applicable to appliances that only discharge the air back into the room)
- The details concerning the method and frequency of cleaning
- There is a fire risk if cleaning is not carried out in accordance with the instructions;
- Do not flambé under the range hood;
- CAUTION: Accessible parts may become hot when used with cooking appliances.

Ducting available at www.siriusbrand.com

6 Year Warranty when Sirius Ducting is used. Full replacement warranty on parts and labour. See website for terms & conditions.

A reduction in the duct diameter from stated ducting size will void warranty.

If you are in doubt about the ducting, please contact Sirius on 1300 762 219 prior to installation

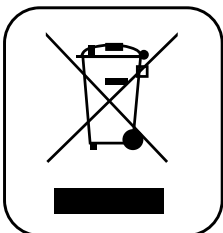

The symbol on the product or on its packaging indicates that this product may not be treated as household waste. Instead it shall be handed over to the applicable collection point for the recycling of electrical and electronic equipment. By ensuring this product is disposed of correctly, you will help prevent potential negative consequences for the environment and human health, which could otherwise be caused by inappropriate waste handling of this product. For more detailed information about recycling of this product, please contact your local city office, your household waste disposal service or the shop where you purchased the product. This appliance is marked according to the European directive 2002/96/EC on waste electrical and electronic equipment (WEEE).

TO THE ATTENTION OF THE USER

This rangehood is designed to work with ducted outside evacuation.



Keep these instructions for use with the appliance. If the appliance should be sold or passed on to others, make sure that the instructions are passed on with it. We thank you for taking note of these suggestions before installing and using the appliance. They have been written for your personal safety and the safety of others.

SAFETY INSTRUCTIONS

These hoods have been designed for personal use in the home. The appliance must be used by adults. Make sure that the appliance is out of reach of children and that they do not use it to play with. Make sure that children do not operate the controls.

- When the appliance is delivered, check the overall appearance of the packaging. **Check PARTS LIST on page 26 for all included parts prior to discarding packaging.**

Any remarks should be written on the delivery docket, of which you keep a copy.

Your appliance is designed for normal domestic use. It is not designed for commercial or industrial use, or for purposes other than those for which it was designed.

- Any consequences of or damage from incorrect installation or incorrect use of the appliance will not be covered by the manufacturer's guarantee.
- Do not ever change or try to change the characteristics of this appliance. This would be a danger. Repairs must be performed only by an authorised technician.
- Always disconnect the hood before carrying out cleaning or maintenance operations.
- Adequately ventilate the room when a rangehood and other appliances, powered by energy other than electricity, are used simultaneously, so that the hood does not suck any combustion fumes.
- It is not allowed to cook food over open flames (flambé) or operate gas hobs without pots or pans on them under the hood itself (the flames sucked into the hood might damage the appliance).
- Frying under the appliance must be done under constant supervision as hot oils and fats may ignite.
- Respect the guidelines for cleaning and replacement of grease filters. Accumulated deposits of grease are a fire hazard.

- This appliance must not be used over cook tops powered by wood or coal or in any case, over cook tops with power levels that could damage the appliance.
- Never use steam or high-pressure devices for cleaning your hood (regulations regarding electrical safety).
- Never use the rangehood without the grease filters.

At Sirius, we are constantly seeking to improve our products. We reserve the right to modify their technical, functional, or aesthetic characteristics deriving from their upgrading.

Motors manufactured and approved by Sirius only are to be used at all times. Failure to comply with this will result in the forfeit of the manufacturer warranty.

The air collected must not be conveyed into a flue used for smoke or fumes from appliances powered by anything other than electricity (central heating systems, bathroom and toilet exhausts, etc.). As far as discharging exhaust air is concerned, please follow the guidelines given by competent authorities.

HEIGHT CLEARANCES: SLT977EMEL, SLT978EMEL

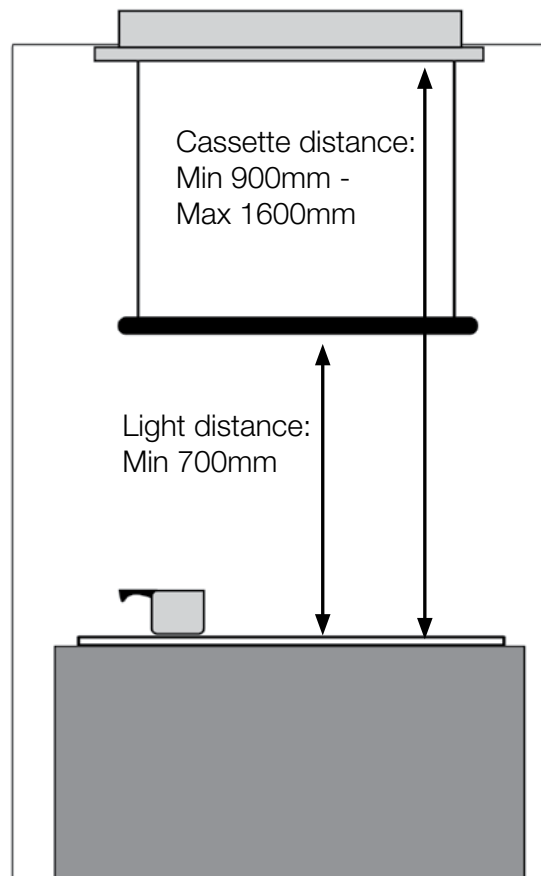



Check PARTS LIST on page 26 for all included parts prior to discarding packaging.

PRE-INSTALLATION CHECKS

Connect all of the electrical components to the unit and motor to make sure both the unit and the motor are functioning properly (see page 15 for instructions).

Remove all connections and proceed with installation if both unit and motor are fully operational.



Installation must comply with the regulations in force regarding the ventilation of enclosed environments. In particular, discharged air must not be conveyed into a duct used for fumes discharge or discharge from appliances using gas or other combustible materials. Air cannot be ducted into roof space.

The use of discontinued ducts is not allowed without the approval of a qualified technician.

BEFORE YOU INSTALL

Sirius warranty covers only Sirius product. If you choose to install a non-Sirius branded accessory such as flexible ducting, Sirius will only warrant the hood and motor. If installation or inferior parts are found to be the cause of failure or issue then charges will apply for service and parts.

Flexible ducting is not permitted under any circumstances. Flexible ducting has been found to increase noise levels, increase vibration and reduce airflow. Sirius Semi-rigid or solid ducting can be used in lieu. There is a range available to suit any application.

Available at www.siriusbrand.com

**A reduction in the duct diameter from stated ducting size will void warranty.
If you are in doubt about the ducting, please contact Sirius on 1300 762 219 prior to installation.**



Before proceeding with the installation of the ceiling cassette, please thoroughly inspect the entire unit (including the motor) for any damages, including all of the electrical connections. If any damage is found, cease installation and report it immediately to the retail partner that the cassette was purchased from.



- Only use Sirius Ducting with a maximum length of 7 metres & minimum of 2 metres from the outlet collar on the cassette to the motor location.
- Limit the number of elbows in the ducting, since each 90 degree bend reduces the air capacity by 1 lineal metre (e.g. if there are 2 x 90 degree bends, the maximum duct length should not exceed 5 metres.)
- Avoid abrupt changes of direction where possible, bends of more than 90 degrees should be avoided at all costs.
- A minimum of 150mm ducting is applicable to the SLT977EMEL and SLT978EMEL.



Reduction of the ducting diameter will void the manufacturer warranty as it will severely affect the performance of the motor and may cause damage with prolonged usage.



Use ducting approved by standards enforced, see www.siriusbrand.com for details for approved ducting. The manufacturer will not be deemed responsible for air capacity and noise problems caused by failure to comply with the above and no warranty on the product will be provided.



FAILURE TO INSTALL THE SCREWS OR FIXING DEVICE IN ACCORDANCE WITH THESE INSTRUCTIONS MAY RESULT IN ELECTRICAL HAZARDS OR ELECTROCUTION.



The cassette requires one 10AMP GPO located inside the ceiling cavity to power both the lighting and the motor.

ATTACHING THE PENDANT LIGHT

Step 1a: The Filter Cover is held in place via four magnets. Accessibility to the filters is achieved by gently pulling down on the cover as per fig.1

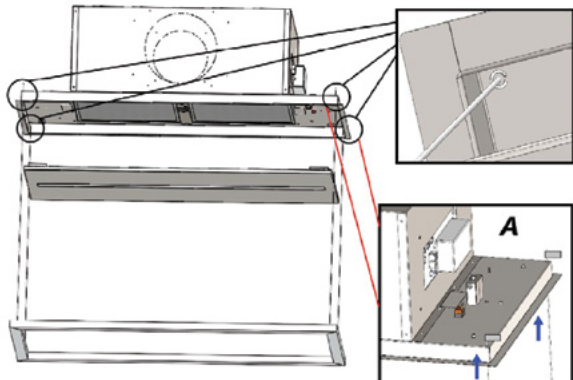

Fig.1

Step 1b: This panel will be held on via four cables to prevent it falling. For installation it is required to unhook these cables and remove the panel altogether.

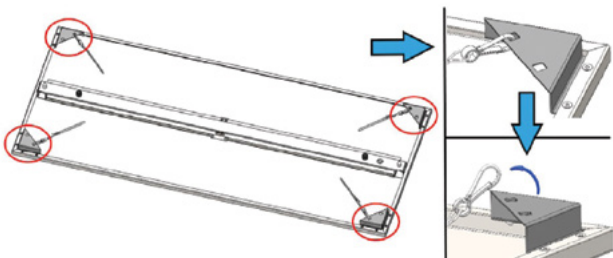

Fig.2

Step 1c: Once the panel is removed, lift the clip of the filter and pull down to remove them from the rangehood

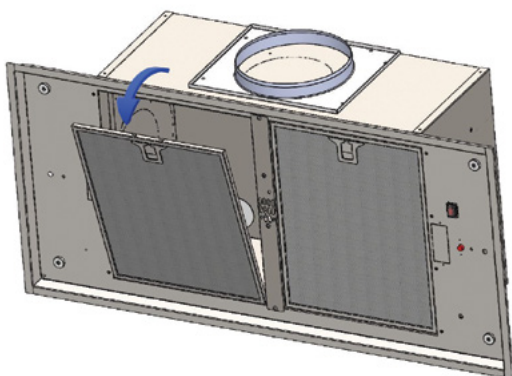

Fig.3

Step 1d: Feed the cables through the four holes in each corner of the rangehood ensuring that the labelled + positive and - negative cables go into the correct holes. Failure to do this may cause damage to the unit when it is first turned on.

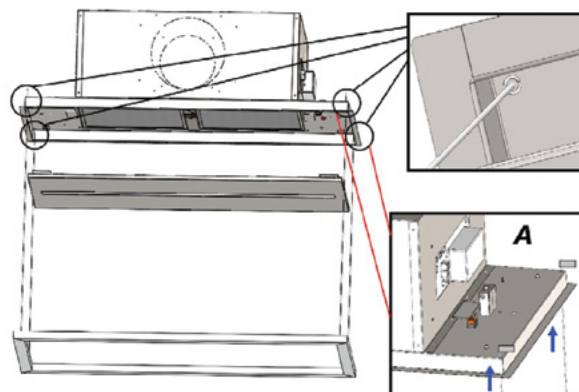

Fig.4

Step 1d: After feeding the cables through the rangehood, using the four supplied grub screws, fix the light into place by allowing the cables to pass through their centre and tightening them down.

(NOTE: Depending on your circumstance and accessibility to the cassette, determining the exact height of the pendant light may be required to do so prior to fitting the unit to the ceiling)

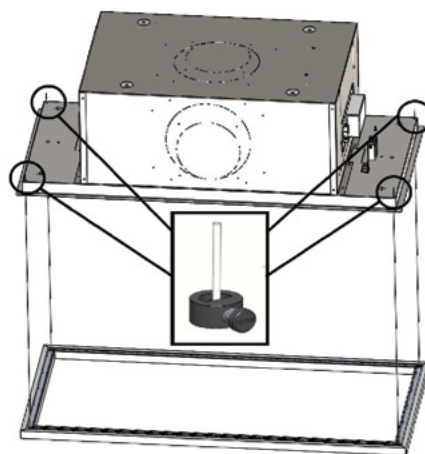

Fig.5

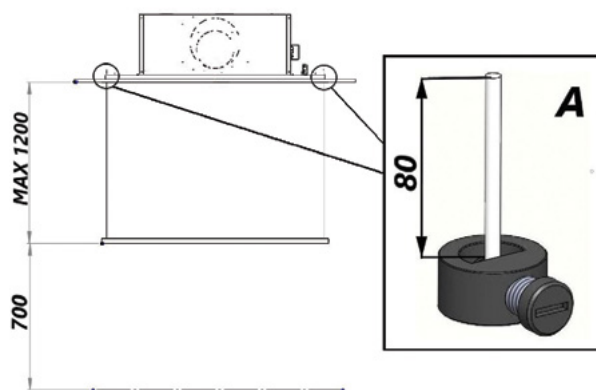
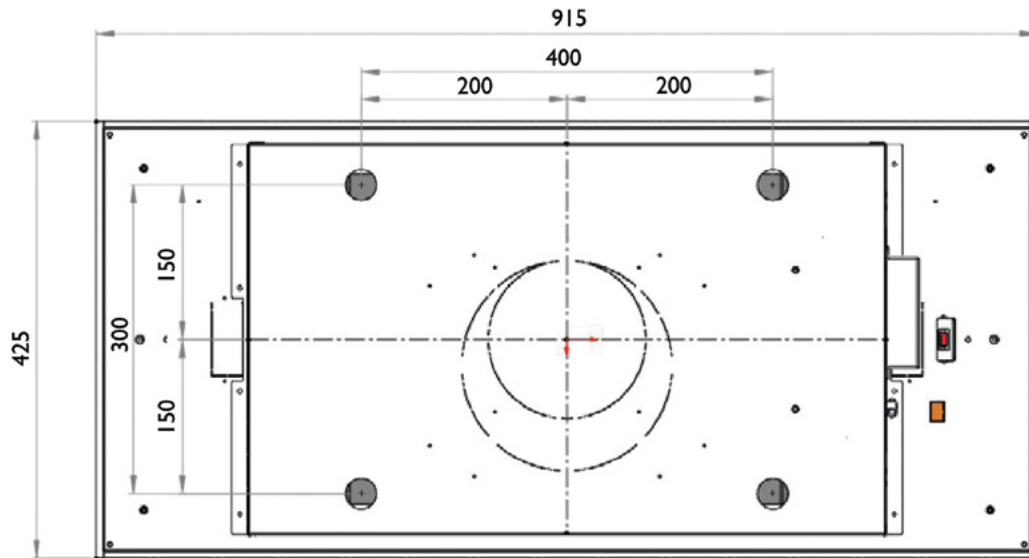

Fig.6

LINE MEASUREMENTS FOR CEILING CUTOUTS AND MOUNTING HOLES

Fig.7



As every installation will differ slightly depending on the ceiling cavity of the dwelling, this installation shall be used as a guide only.

- These cassettes are held in place with the use of the 4 x 250mm threaded bolts. Using the measurements in the Fig. 7 line drawings ensure that there is timber framework (not supplied) inside the cavity to support the weight on the cassette. Please refer to each individual measurement for the exact location of the mounting holes or take a physical measurement of the location when the cassette has been unpackaged.



INSTALLING THE TIMBER SUPPORT BEAMS

- After running the timber support beams in the cavity above, pre-drill 4 x 8mm holes through the timber and pass the 4 x 250mm bolts through them, ensuring that the **larger washer** is on the **INSIDE OF THE CEILING CASSETTE**. (Fig. 8a)

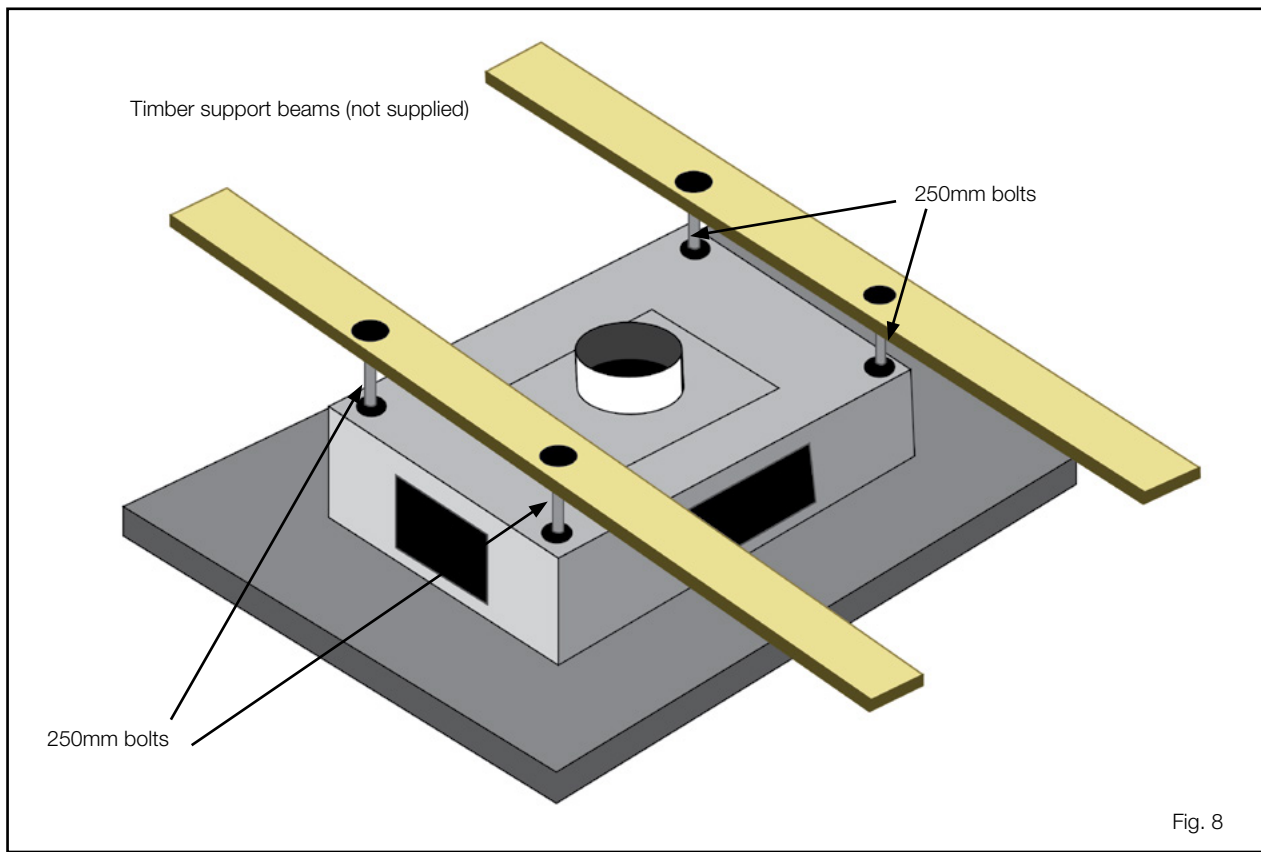

- Lift the cassette into position and ensure that the 4 x 250mm bolts pass through the mounting points. Fit the larger diameter washer first and then wind the wingnut up the thread and tighten the cassette into position. These will enable you to flush the unit tight with the ceiling (Fig. 8a).



MOTOR AND VENTING OPTIONS:
SLT977EMEL, SLT978EMEL (150mm DUCTING)

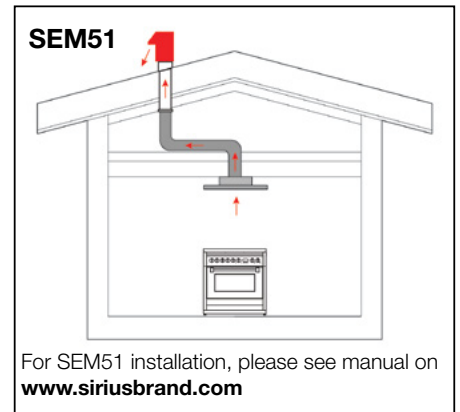
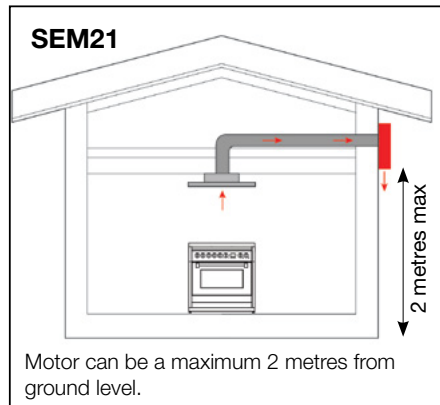
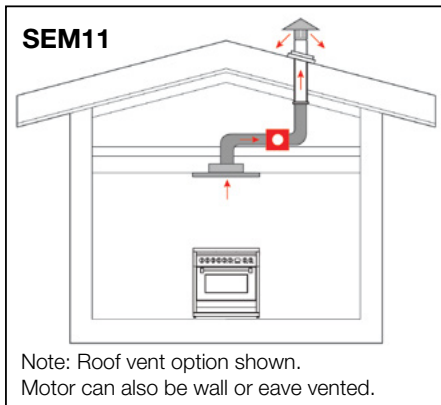

Motor MUST be accessible for servicing at all times.

TOP VENT INSTALLATION

1. Knock out the 150mm plate on the top of the unit and attach the 150mm adaptor plate (Part 'A')
1. Use 150mm ducting.
2. The ducting fits directly onto the collar on the top adaptor plate (Part 'A').
3. Fix in place using a universal ring clamp (Part 'D').

INTERNAL MOTOR:

Ducting to SEM11 (150mm)

Please note that the final exit point for SEM11 can be through the roof, wall or eave vent.

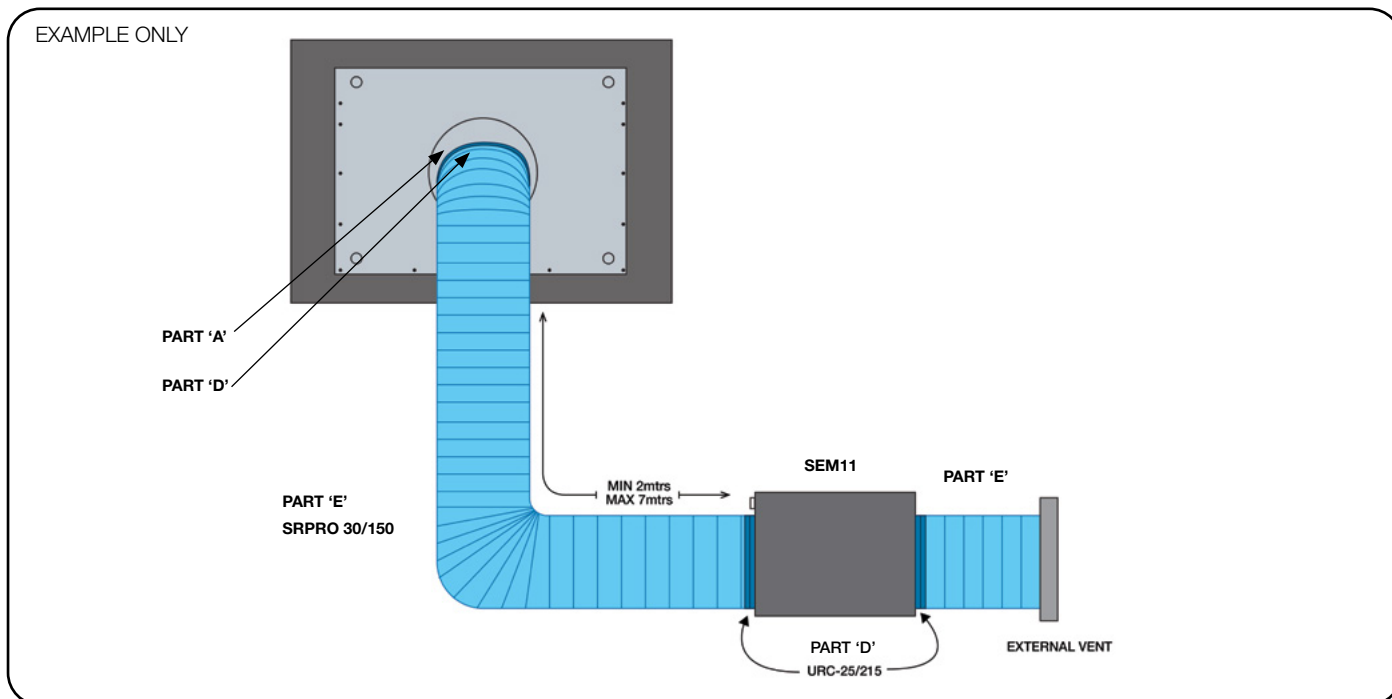

EXTERNAL MOTOR:

Ducting to SEM21 (150mm)

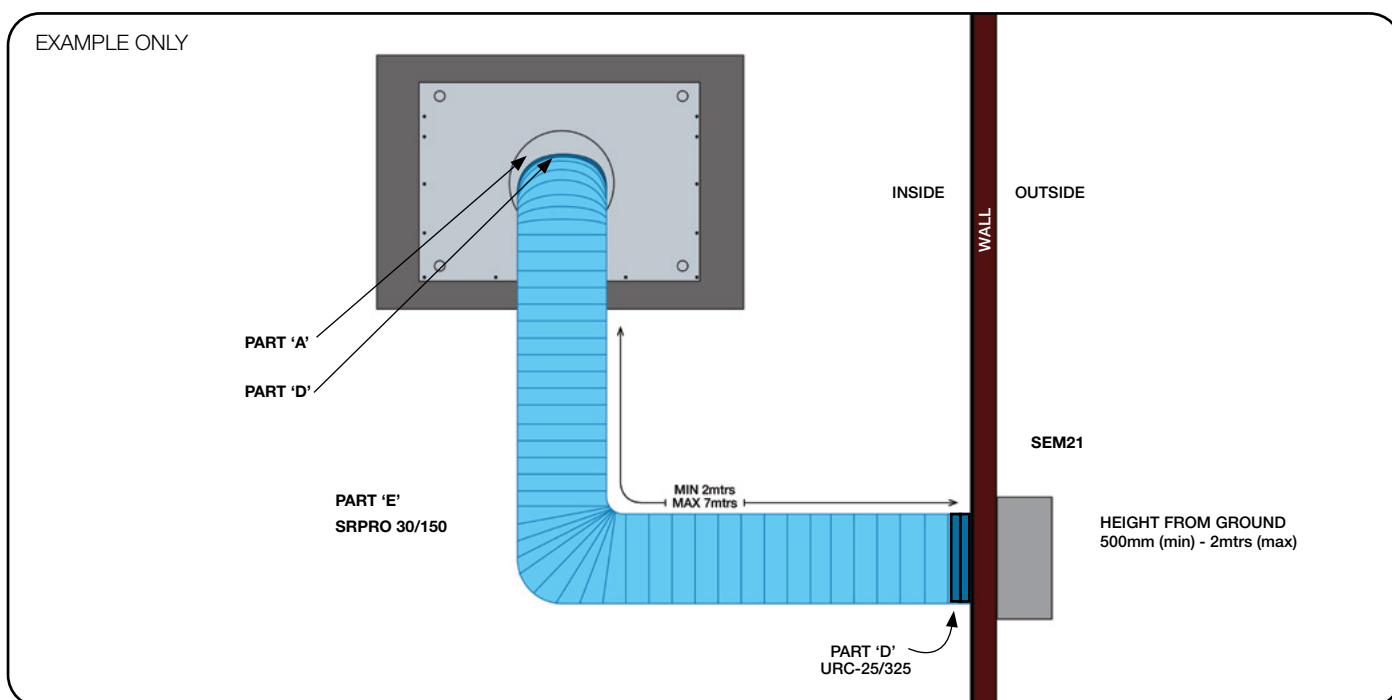

EXTERNAL MOTOR: Ducting to SEM51 (150mm)

Download SEM51 user manual from www.siriusbrand.com

SIDE VENT INSTALLATION:

150mm DUCTING: SEM11 MOTOR (INTERNAL)

1: Knock out the 150mm plate on the chosen long or short side of the unit & attached the 150mm adaptor plate (Part 'A')

2A: Connect the length of ductwork (Part 'E') directly to Part 'A', then secure with a universal ring clamp (Part 'D').

3A. Secure to the motor with a universal ring clamp (Part 'D').

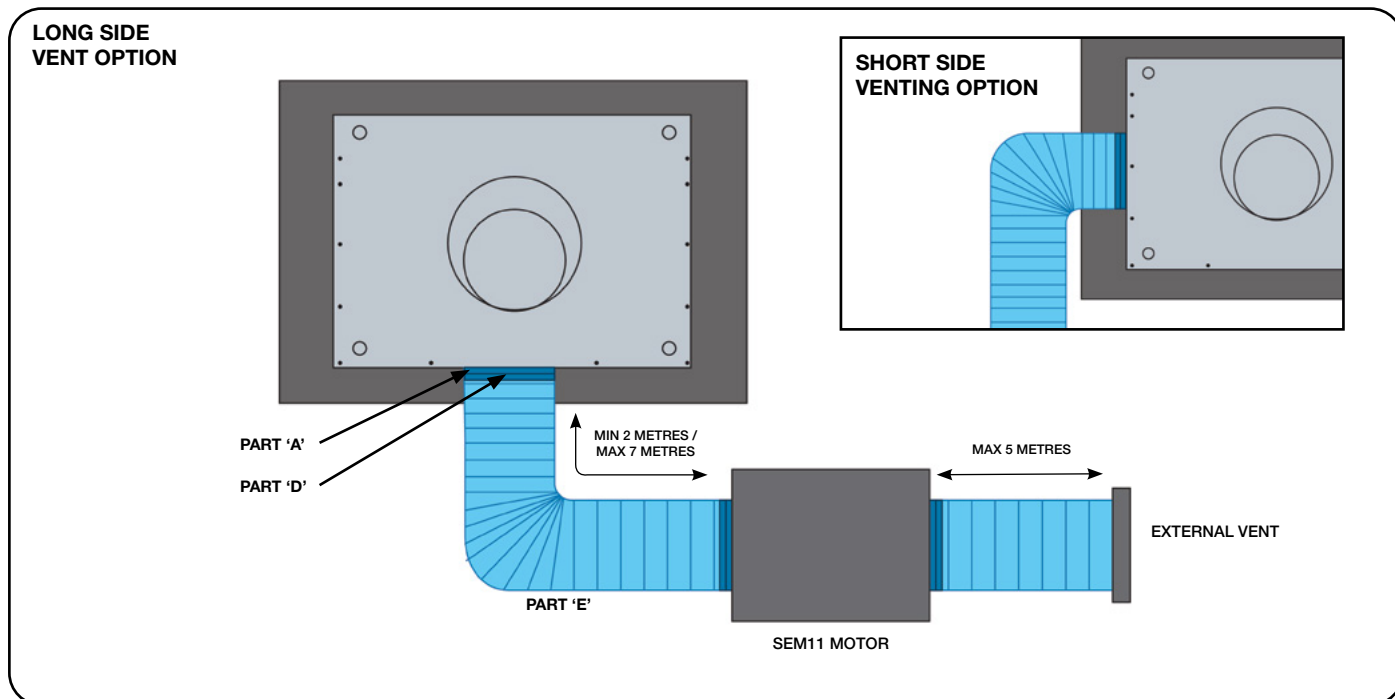

SIDE VENT INSTALLATION:

150mm DUCTING: SEM21 MOTOR (EXTERNAL)

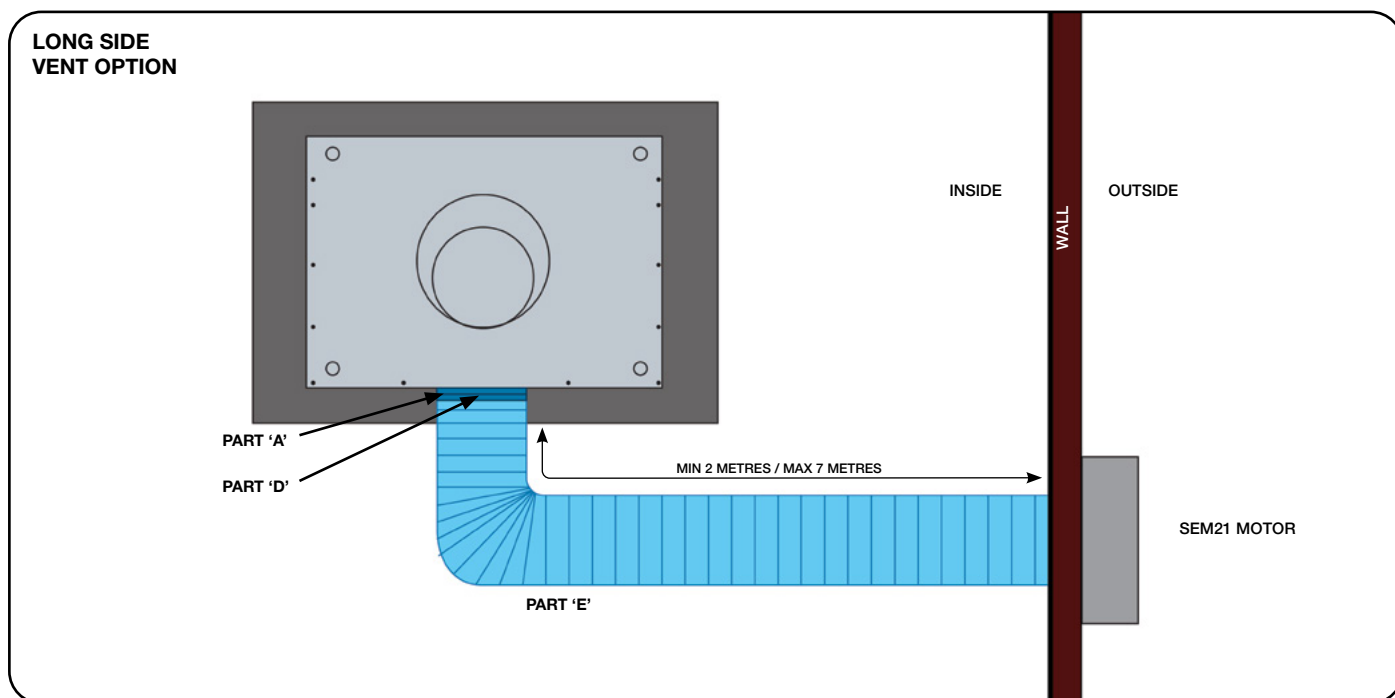

DUCTING FROM MOTOR TO EXIT POINT: (SEM11)

After completing the ducting from the Rangehood to the motor location, either a roof, wall or eave exit point can be used. To see the range of Easykits available please head to www.siriusbrand.com or contact your retailer.



The location of the motor is to be no less than 2 metres away from the rangehood.

**Failure to do so may result in additional noise level of the ceiling cassette.
Maximum distance is 7 metres, however 3 - 5 metres is optimum to minimise noise and maximise performance.**

DUCTING KITS



Easy Roof Kit



Easy Eave Kit



Easy Wall Kit

ELECTRICAL CONNECTION

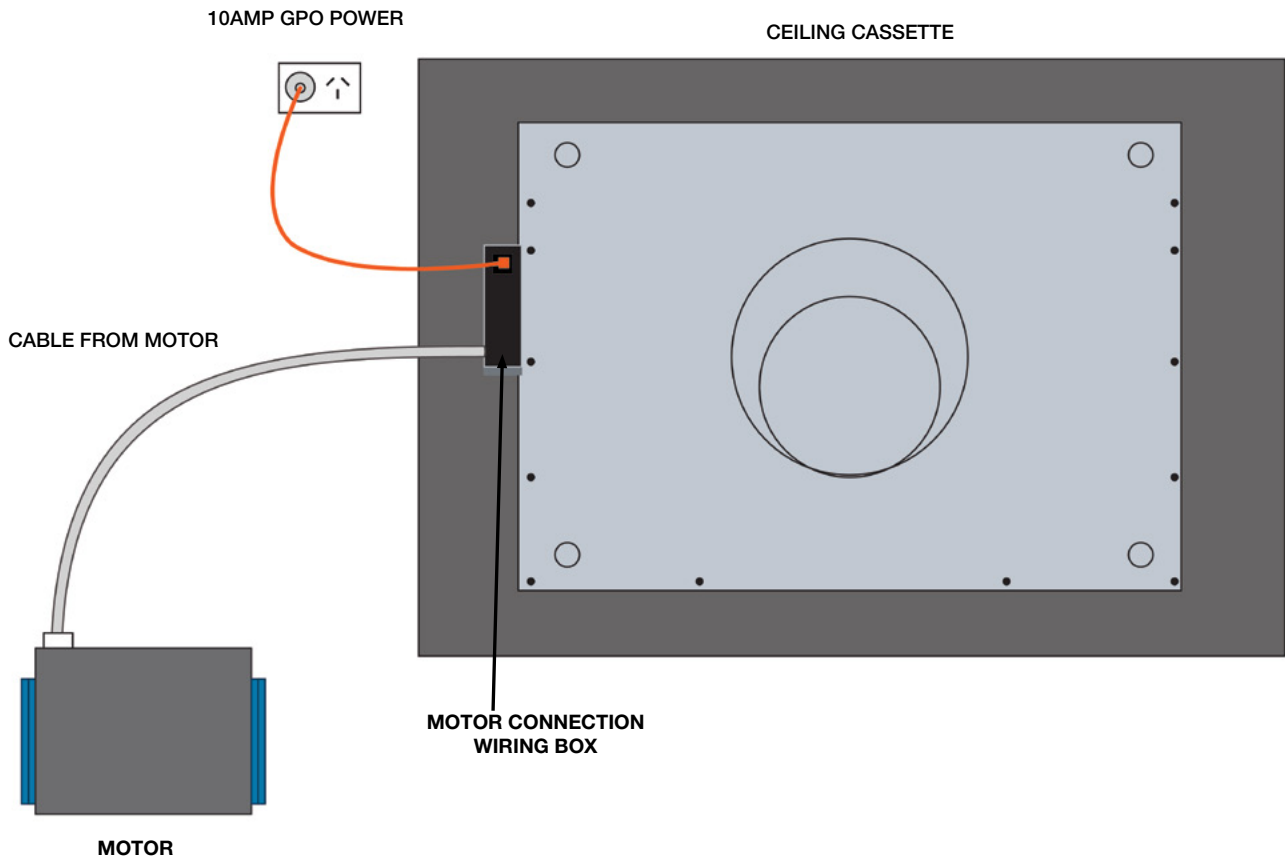

MOTOR WIRING CONNECTION

1. Remove the four screws holding the front of the housing in place to expose the connections.
2. Following the wiring chart on the front of the housing, connect each wire to the matching colour, making sure that this is done correctly before running power to the unit.
3. Replace the cover and fix the four screws back into place.

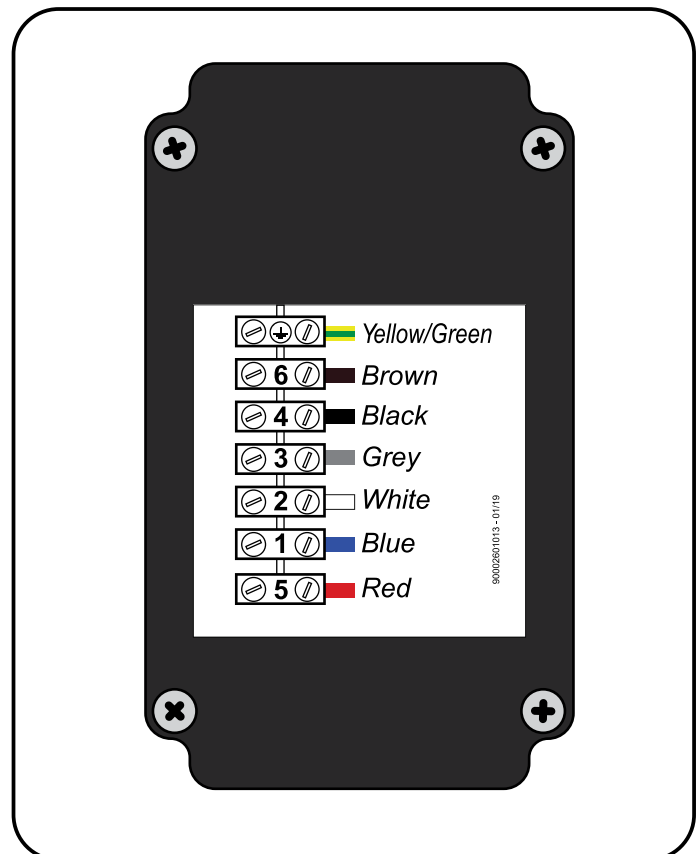

REMOTE CONTROL

Set-up:

6 channel control for rangehood remote.

- When the rangehood is first turned on, hold the lighting button for 5 seconds.

TECHNICAL DATA

- Alkaline battery powered: 12 V mod. 23 A
- Operating frequency: 433.92 Mhz
- Combinations: 32.768
- Max. consumption: 25 mA
- Operating temperature: -20 ÷ + 55 °C
- Dimensions: 120 x 45 x 15 mm.

OPERATING DESCRIPTION

The transmitter is equipped with 5 buttons for rangehood management, as specified below:

- ☀ : Light ON/OFF command.
- ⏻ : Motor ON (speed level 1) / OFF command.
- : Reduce speed.
- ⊕ : Increase speed.
- ⌚ : 10-minute timer.

INITIAL OPERATING CONDITION

The manufacturer supplies the radio control unit ready to be used with codes preset in the factory.

Dimmable lights function:

SLT977EMEL, SLT978EMEL models only

This function provides for lights dimmability, ranging from 20% to 100%, by continuously pressing the Light ON/OFF ☀ on the remote control.

Functions are the following:

- Light ON or OFF: shortly press the Light ON/OFF button: ☀
- Change light brightness: When light is on, continuously press the Light ON/OFF key ☀ to adjust the brightness. Stop pressing the button to set the brightness level.

Colour temperature settings:

SLT977EMEL, SLT978EMEL models only

Make sure that the lights and the fan are off.

Holding down the TIMER key ⌚ will turn on the light at the previously set colour temperature.

Press and hold the Light ON/OFF key ☀ to change the colour temperature.

As long as the key is kept pressed, the colour temperature is changed from warm to cold. Release the Light ON/OFF button ☀ to select the desired colour.

Exit the colour temperature selection function by pressing the motor ON/OFF button ⏻.



OPERATION MODE

Standard configuration:

Standard configuration requires all rangehood radio control systems to be provided with the same transmission code. In the event two rangehoods are installed in the same room or nearby, each system may affect the operation of the another. Therefore, the code of one radio control system must be changed.

Generating a new transmission code:

The radio control system is provided with preset codes. Should new codes be required, proceed as follows: Press simultaneously buttons:



for two seconds. When LEDs are on, press buttons:

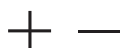

(within 5 seconds). The LEDs flashing 3 times indicate the procedure is completed.

WARNING! This operation deletes permanently the preset codes.

Learning the new transmission code.

Once the transmission code is changed in the radio control unit, the electronic central unit of the cooker hood must be made to set the new code in the following way:

Press the main power-off button of the hood and then restore power to the electronic control unit. Within the next 15 seconds, press the Light Button to synchronise the central unit with the code.

Reset of the Factory configuration:

To restore the Factory configuration, follow the procedure described below: press simultaneously buttons:



for 2 seconds. When LEDs light on, press buttons:

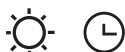

(within 5 seconds). LEDs flashing 6 times indicate the procedure is completed.

WARNING! This operation deletes permanently the preset codes.

Emergency button:

In the event that the radio control does not work, use the emergency button to switch the appliance off. After any necessary repairs have been performed, reset the emergency button.

THE SIRIUS APP

DOWNLOAD SIRIUS APP FOR ANDROID

1. Open the Google Play Store App 
 2. Search or browse for SIRIUS App.
 3. Select it.
 4. Tap to Install.
 5. Follow the onscreen instructions to complete the transaction and get the content.
- You can change what language is displayed when you visit Google Play on your computer by changing your Google Accounts settings.
- Note: Apps are designed for use with supported Android and Chromebook devices and can't be used on Windows or Mac computers.

DOWNLOAD SIRIUS APP FOR iOS

Notes:

- After requesting an app, you may be asked to verify your identity by entering your passcode or by using Touch ID or Face ID.
 - The steps below don't apply to the iPhone 5c, iPhone 5, iPhone 4s or the iPhone 4.
1. Open the App Store 
 - To install apps, you must sign in with your Apple ID or create one.
 2. To browse the App Store, tap Apps (at the bottom).
 3. Tap Search (at the bottom) then enter SIRIUS App.
 4. Tap the app.
 5. Tap GET then tap INSTALL.
 - If you have a compatible iPhone with Face ID enabled, double-tap the Side button then look at the screen to authenticate.
 6. If prompted, sign in to the iTunes Store to complete the install

CREATE YOUR ACCOUNT ON SIRIUS APP.

1. From Home App, Tap on Join now.

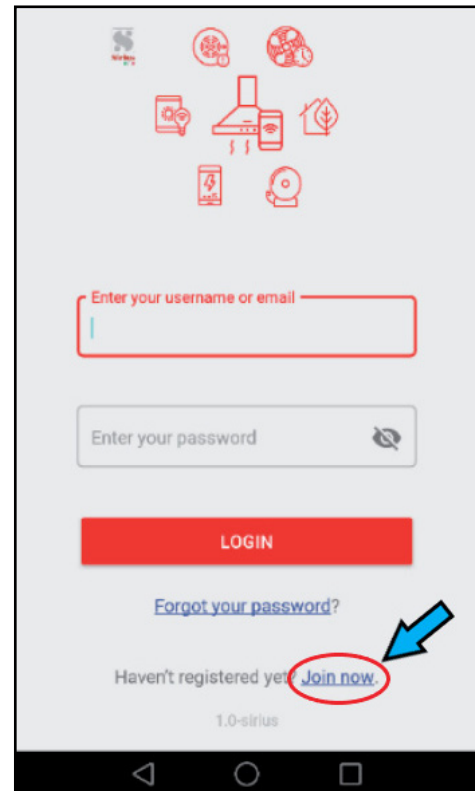

2. Insert your account data

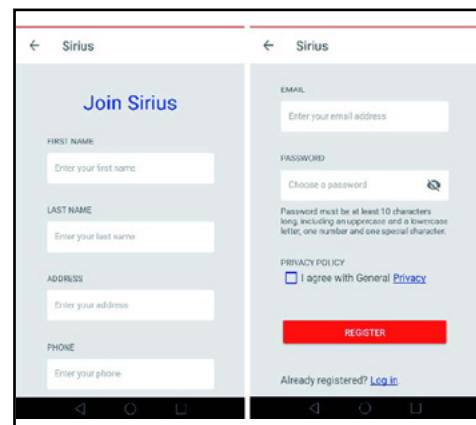

Tap Agree with General Privacy and tap on Register.

3. If all instructions are done correctly a Popup message **“Registration was successful. Check your email for the activation link”** appears.

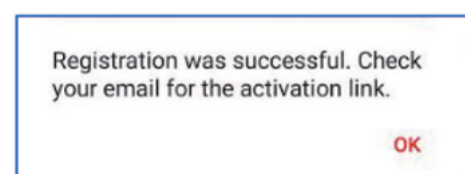

4. Go to your e-mail address and Confirm your account.

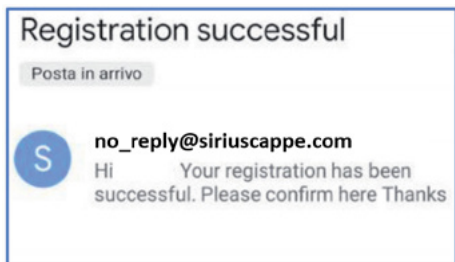

Note: We'll send the email from **service@codermine.com**, so you can quickly search for it. If it isn't in your inbox, check your folders. If a spam filter or email rule moved the email, it might be in the Spam, Junk, Trash, Deleted Items, or Archive folder. If you didn't find yet please create another account.

5. From Login page Insert the e-mail and password of your account and tap LOGIN.

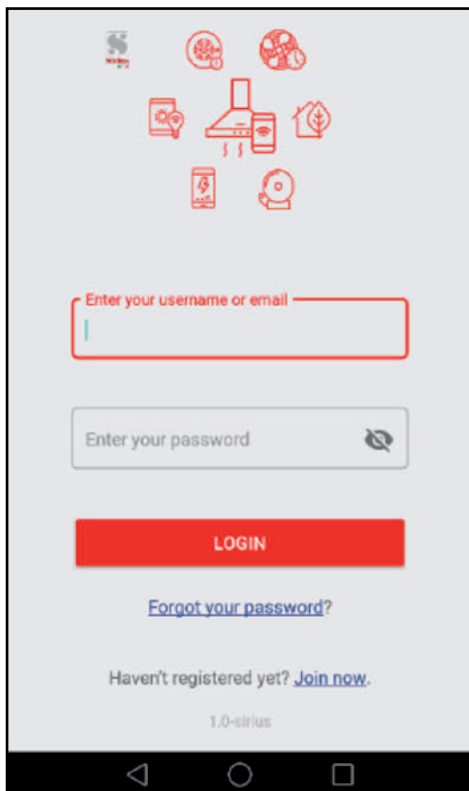

Note: If you forgot your password, tap on **Forgot your password?** insert your e-mail address and tap **Send me a Link.**

PAIRING YOUR PRODUCT

Fast way using the **WPS** procedure, if your router has no **WPS** button, please follow the next instructions.

PAIRING WPS MODE

1. After Login Tap the **☰** App Menu (top left) and select **DEVICES**.

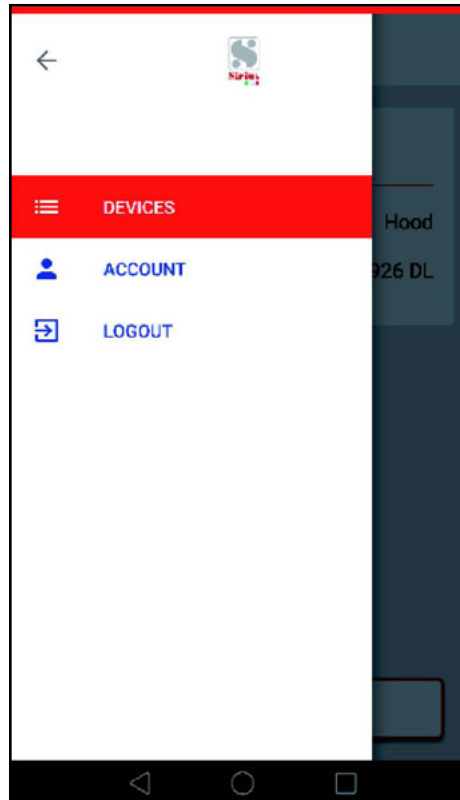

2. Tap **ADD NEW DEVICE**.

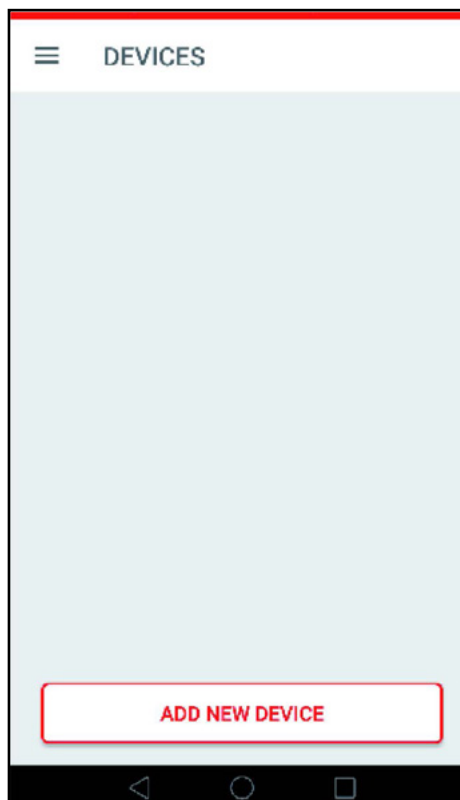

3. Tap USE WPS MODE.

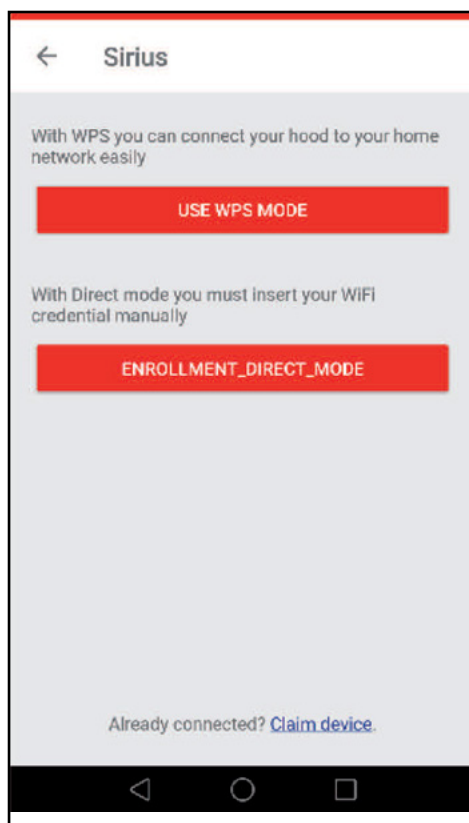

4. On your Router WI-FI press WPS button.



5. On your range hood:

- Switch off completely (light and motor)
- Hold (01) button for 3 sec for settings menu ((7) (01) LEDs will flash)
- Press (2) button to enable WPS pairing.
- Hold (01) button for 3 sec to save.

Note:

If buttons are not pressed within 10 secs the system automatically exits from settings menu and all unsaved operations will be discarded.

6. Press DONE on WPS description.

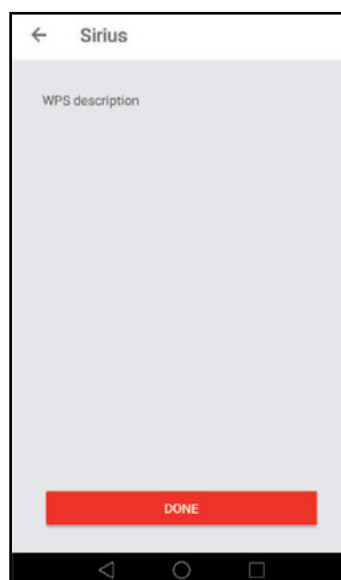

7. Use the QR code reader to connect the product with the App, using the label on the brochure or using the label located inside the product, found on the motor when you remove the grease filters.



8. Press ACTIVATE DEVICE and you have a pop-up message.

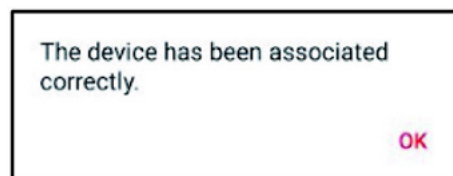

8. Tap the device icon. Enjoy your device.

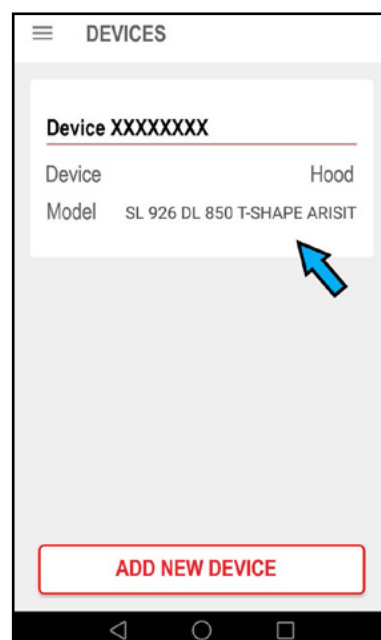

PAIRING MANUAL MODE

1. After **Login** Tap the **☰ App Menu** (top left) and select **DEVICES**

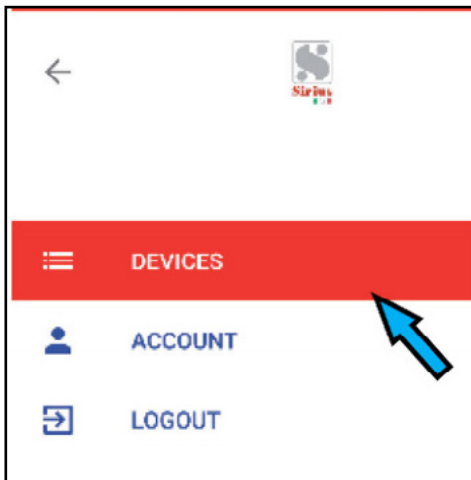

2. Tap **ADD NEW DEVICE**

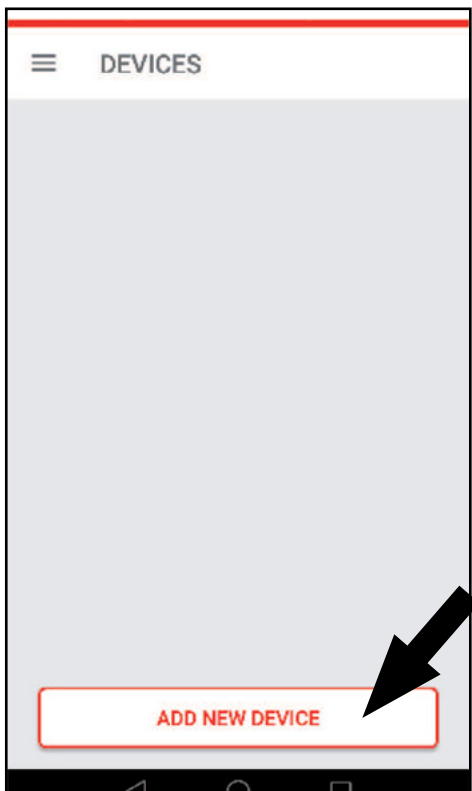

3. Tap **ENROLLMENT_DIRECT_MODE**

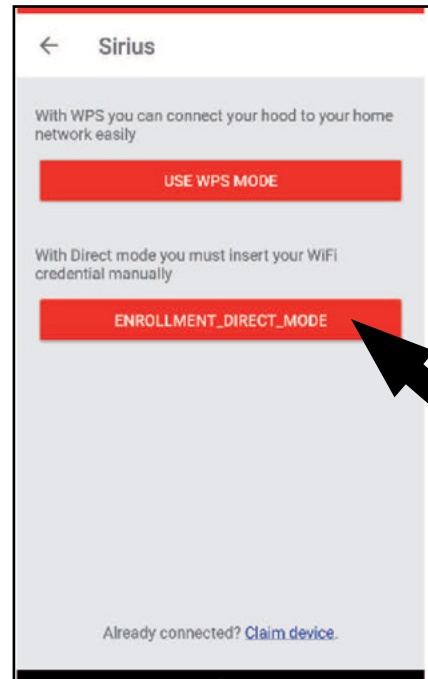

4. **ON YOUR RANGE HOOD:**

- Switch off completely (light and motor)
- Hold **01** button for 3 secs for settings menu (**01** LEDs will flash)
- press **3** button to enable manual pairing
- Hold **01** button for 3 sec button to save.

Note:

If buttons are not pressed within 10 secs the system automatically exits from settings menu and all operations unsaved will be discarded.

5. Tap **OPEN SETTINGS**

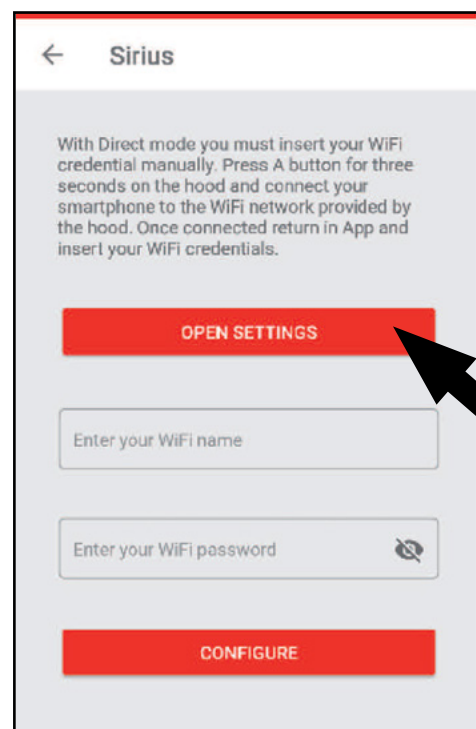

6. Connect to **“HOOD network”** inserting as passwork “password”.

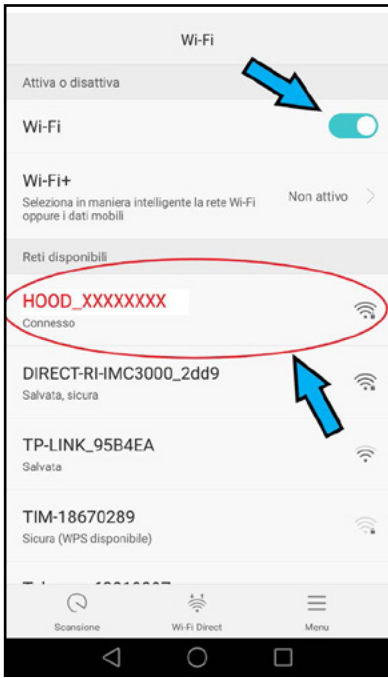

7. TURN BACK

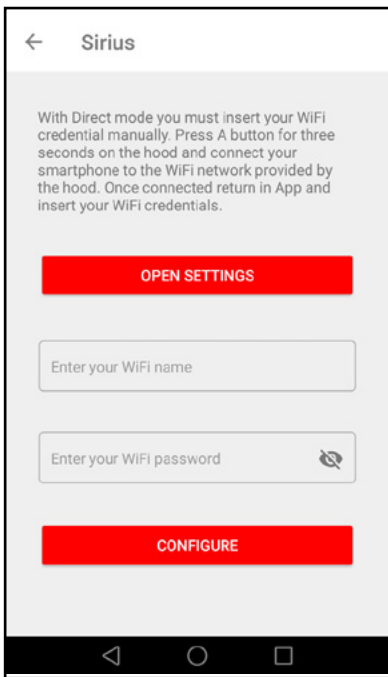

8. ENTER WI-FI NAME AND WI-FI PASSWORD

9. TAP CONFIGURE

10. IN CASE OF FOLLOWING ERROR:

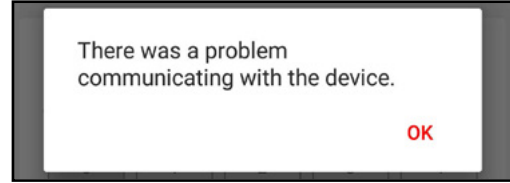
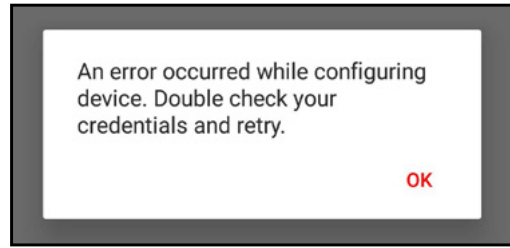

Go back to the home page.

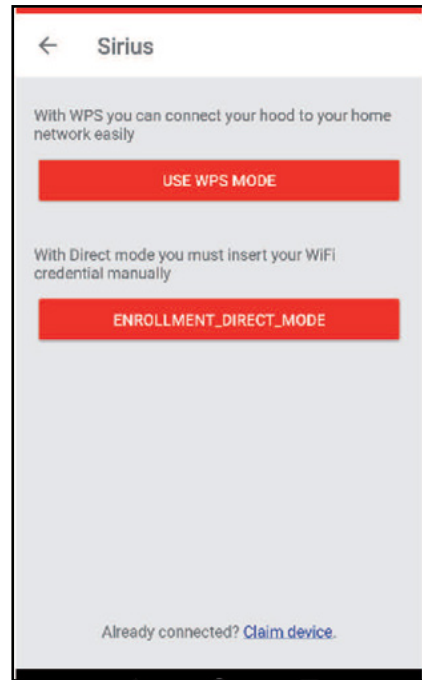

TAP “Claim Devices”.

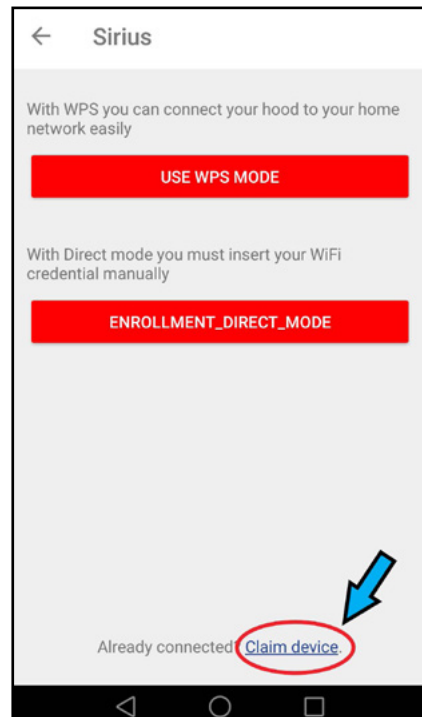

11. Use the QR code reader to connect the product with the App, using the label on brochure or using the label located inside the product, visible by removing the grease filters.

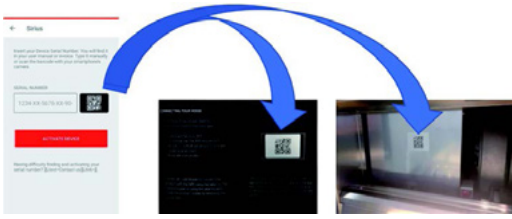

12. Connect your mobile to your home **Wi-Fi Router** network.

13. Press **ACTIVATE DEVICE** and you have a pop-up message.

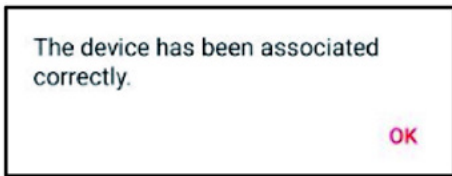

14. Tap the device icon. Enjoy your device.

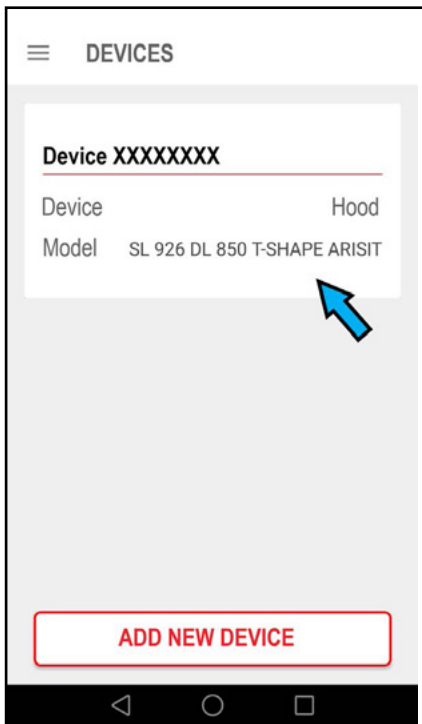

REMOVE ONE DEVICE FROM APP

1. After Login Tap the  App Menu (top left) and select DEVICES

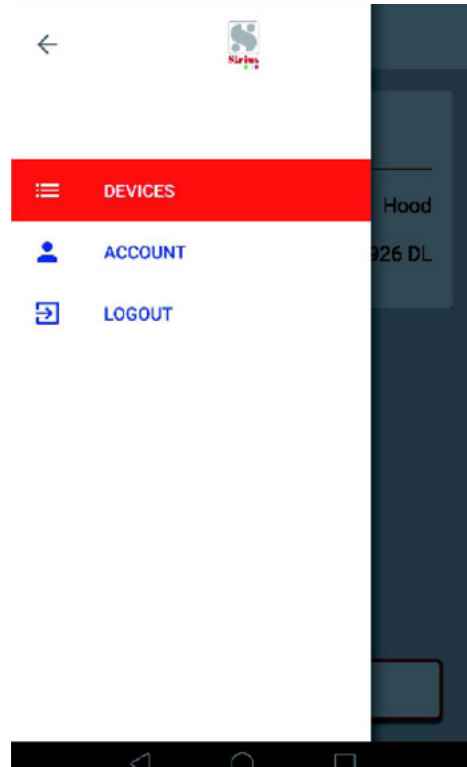

2. On **DEVICES** slice your device on left and tap **Remove**.

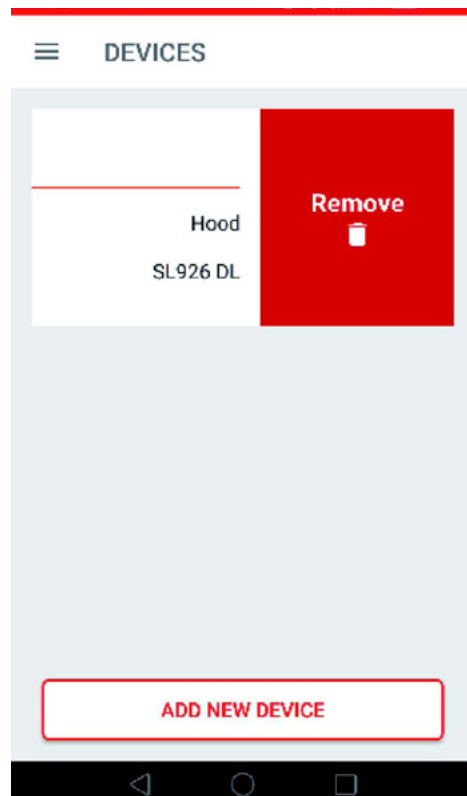

FUNCTIONS

Timer

Tap on  and set the minutes for shutting down the device.

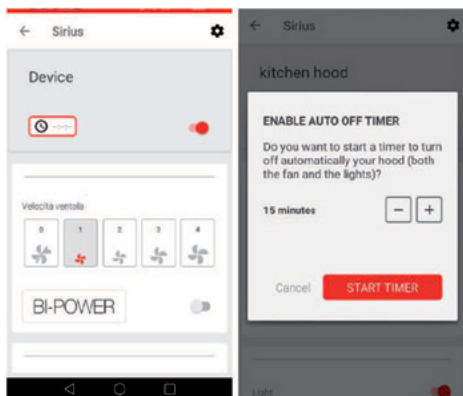

Fan speed

Tap on the speed you want, select '0' for switching OFF.

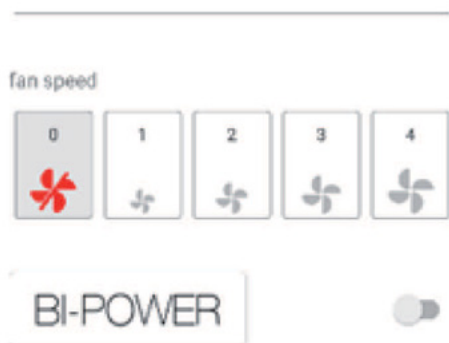

BI-POWER

The BI-POWER function allows reducing the performance of the fan, if the maximum efficiency of the product is not required.

LIGHT

Slide the toggle switch for switching ON/OFF.

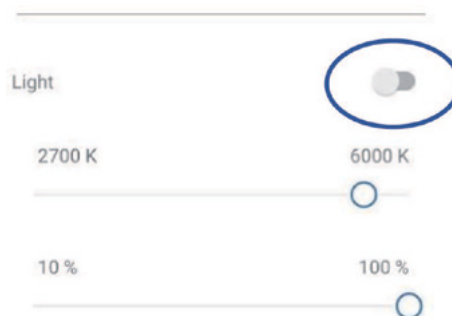

Slide the scrollbar for setting the colour temperature (°K)

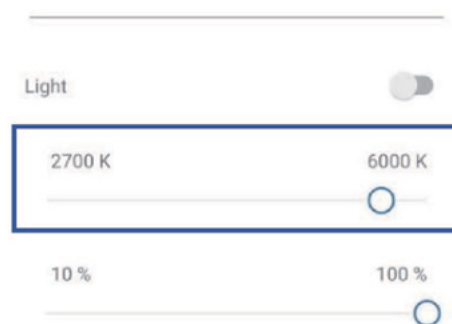

Slide the scrollbar for lights dimmability, ranging from 10% to 100%.

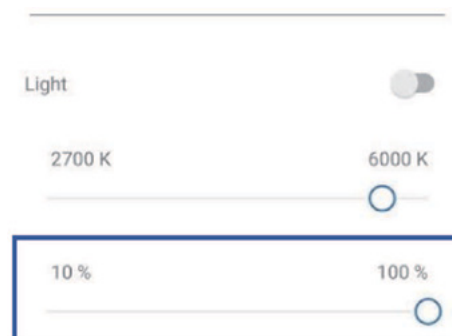

FILTERS CLEANING

 FILTER

Hours of use left before you need to provide maintenance.

 Filters
INOX

28h

RENAME DEVICE

Tap on  and rename device.

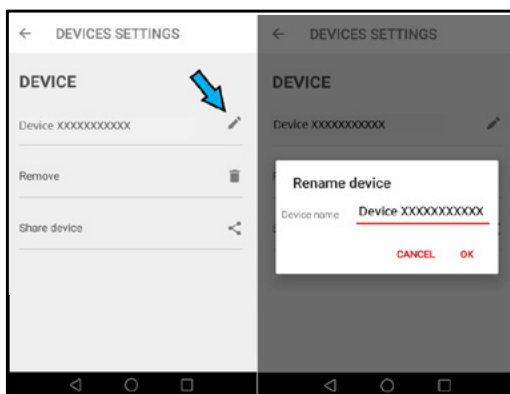
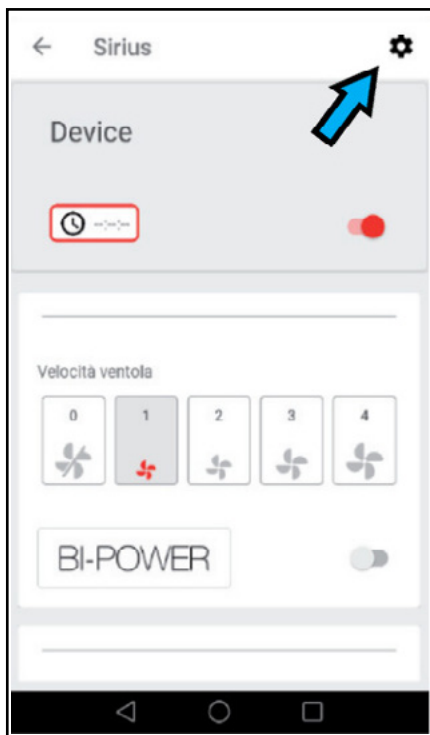

SHARE DEVICE

Tap on  and share device only to subscribed account.

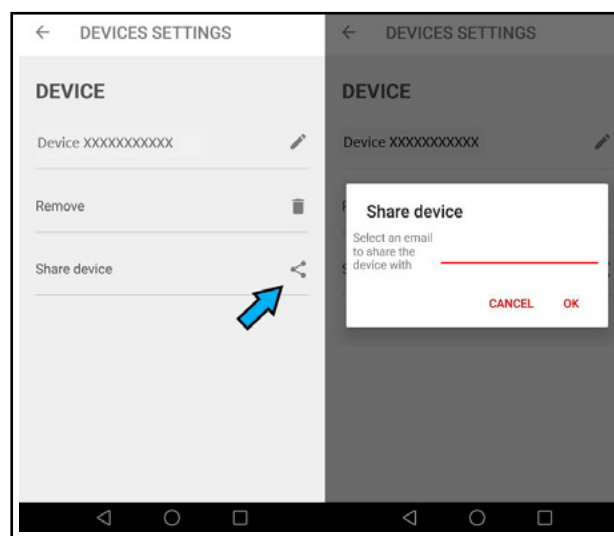

PARTS LIST (INCLUDED)

PART A

150mm adaptor plate

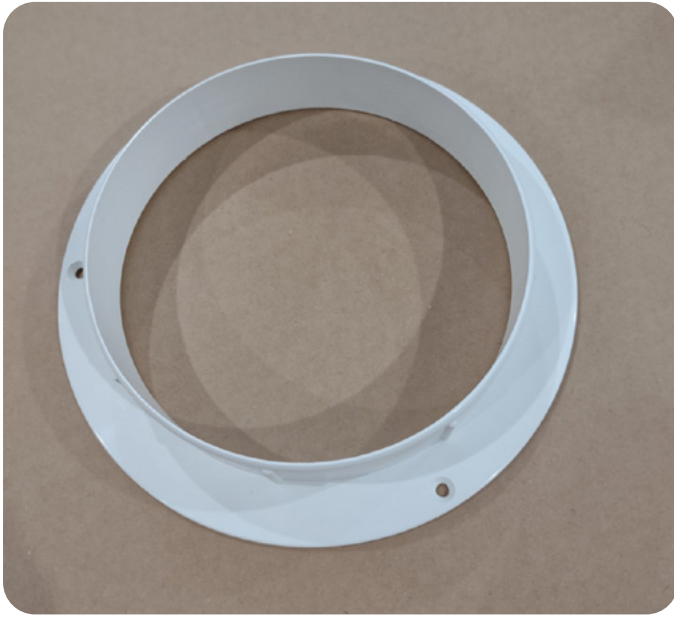

PART B

10mm Adaptor mounting screws



PART C

Threaded support bars



OPTIONAL PARTS LIST

PART D

Universal ring clamp
URC25-215/325



PART E

Semi rigid aluminium ducting 150mm
SRPRO 30/150



WIRING DIAGRAM: SLT977EMEL, SLT978EMEL

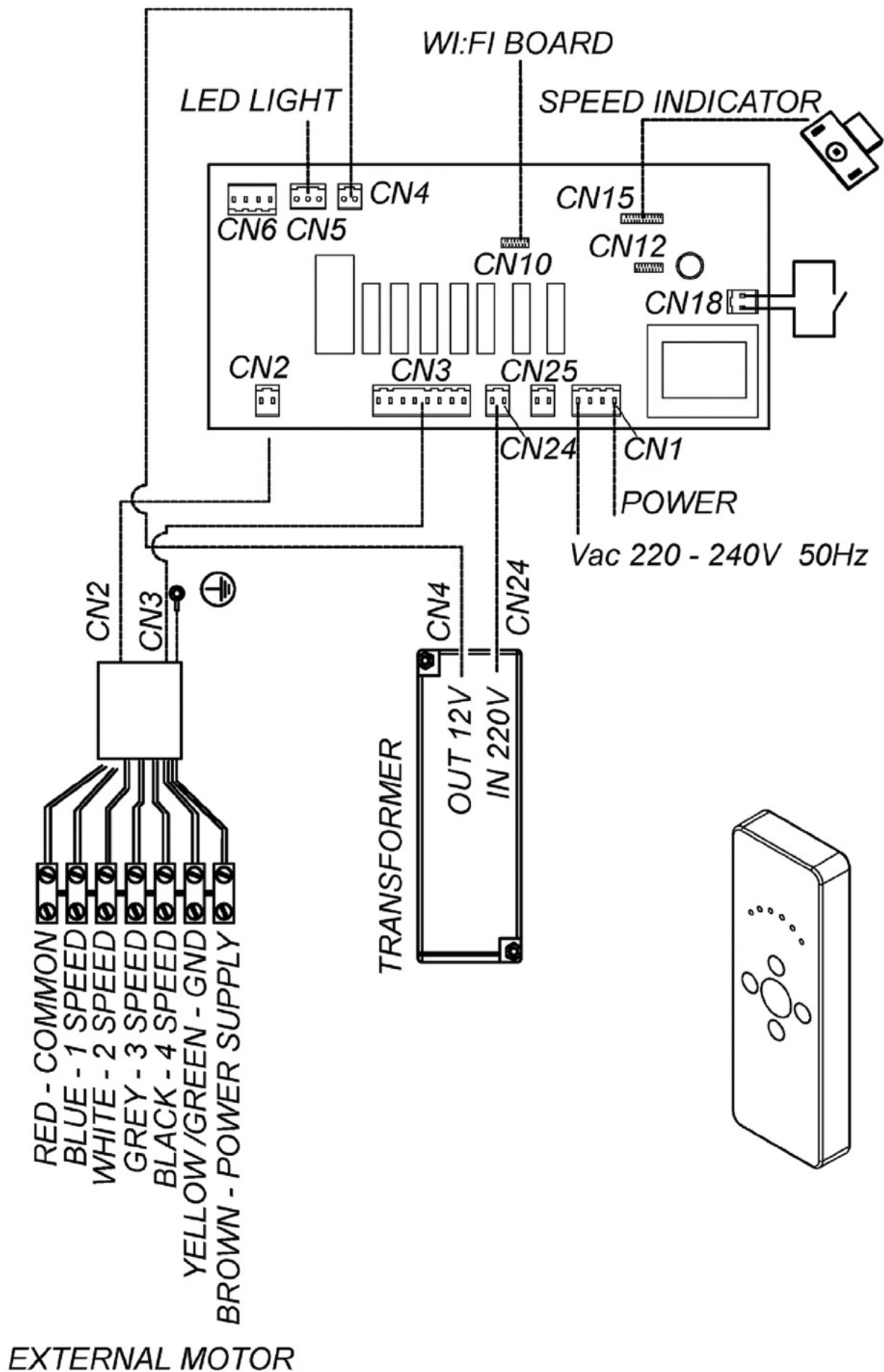

WARRANTY INFORMATION



Sirius

Dear Customer,

Thank you for choosing this Sirius Rangehood.

We are sure that it will provide you with many years of excellent service. At Arisit Pty Limited we are dedicated to ensuring that our customers receive the best possible after-sales care.

The Sirius 'Protection Plan' has been devised to give you added peace of mind. Should you encounter any problems with your appliance, our nationwide team of specially trained technicians will deal with your call swiftly and efficiently.

PRIORITY SERVICE, ACCESSORIES & SPARE PARTS

AUSTRALIA

ARISIT PTY LIMITED
40-50 Mark Anthony Drive, Dandenong South,
VIC 3175, Australia
Phone: 1300 762 219
Email: consumer.care@arisit.com

NEW ZEALAND

ARISIT PTY LIMITED
1A Howe Street, Newton,
Auckland 1145, New Zealand
Phone: (09) 306 1020
Email: sales@aristonappliances.co.nz

Warranty

By registering your ownership NOW, you qualify for Sirius's Total Peace of Mind Protection Plan.

Australian & New Zealand 3 / 6 Year Protection Plan*

This guarantees your appliance for a full 3 years parts and labour & 10 years for the off-board motors (covering manufacturing defects only) from the date of purchase, subject to the Terms and Conditions overleaf.

***3 Year warranty is extended to a 6 year period only when Sirius ducting is installed.**

 **Year Warranty**
when Sirius ducting is used*
www.siriusbrand.com

Your Warranty

Register now to qualify.

Terms & Conditions

These Terms and Conditions apply only to Sirius products distributed in Australia and New Zealand by Arisit Pty Limited.

1. This warranty applies for a period of 3 years on all products.
 - a) Warranty is extended to a 6 year period when Sirius ducting is installed.
 - b) All off-board motors are covered under warranty for a 10 year period for manufacturing defects only.
2. Warranty applies for parts and labour in Australia and New Zealand, commencing from date of purchase.
3. This warranty applies only to the original purchaser/hire purchaser of this appliance and cannot be assigned or transferred. Failure to produce documentary proof of the date of original acquisition by the original purchaser will result in a charge being levied for work done, labour and parts supplied.
4. This warranty does not apply to:
 - a) Consumable items such as filters, fuses, and light bulbs.
 - b) Damage to body work, paint work, glass, and plastic items (such as, but not limited to windows, covers, baskets, trays, worktops, door handles, control and kick panels.)
 - c) Corrosion & rust damage.

A fee may be charged following warranty claims where no fault is found with the appliance.

5. This warranty will not apply where:
 - a) The fault is caused by accident, misuse, an infestation of insect and or vermin, fire, flood or the use of products not approved by Arisit Pty Limited.
 - b) There has been a failure to comply with the manufacturer's operating and installation instructions.
 - c) Service, modification or repair has been carried out by anybody other than an approved Arisit Service Technician.
 - d) The appliance has been used/ installed anywhere other than a private dwelling, or where it has been used other than for domestic use.
 - e) The appliance is subject to a rental agreement.
6. Any defective part that has been replaced becomes the property of Arisit Pty Limited.
7. This warranty applies only to Sirius appliances purchased and installed in Australia and New Zealand.
8. Loss of use of the appliance or consequential loss of any nature is not covered.
9. A charge may be levied at the discretion of Arisit Pty Limited if the call is deemed unnecessary or if the cause of failure is traced to external sourced such as, but not limited to: blown fuses, power failure, faulty installation, customer misuse or negligence, etc
10. Where the appliance, the subject of a warranty claim or repair, is used or installed more than TWENTY (20) kilometres from the nearest Arisit Service Division or Authorised Service Agent, the cost of delivery to the nearest Service

Division or travel costs for a technician or Authorised Service Agent shall be for the account of the Purchaser. Where a built-in appliance is located or installed outside the Arisit Authorised Service Agent's normal service area, additional travel and labour costs shall be the account of the Purchaser.

11. Service is offered during normal business hours only, also appliances to have a clear access in a serviceable area
 12. Arisit Pty Limited shall not under any circumstances be responsible in terms of this warranty for the replacement or repair of any part of the equipment which may have been damaged in transit, during and after installation or imperfections after installation.
 13. Losses caused by act of God, failure to obtain spare parts, strikes or lockouts are not covered.
 14. External off board motors must be installed a minimum of 2 metres and maximum of 7 metres away from the rangehood. This is for optimum sound and performance.
 15. All motors must be accessible for servicing purposes and if installed above 2 metres from ground height additional cost will be incurred due to OH&S standards for service agents. Prior to install please check minimum & maximum installation details on the Sirius website, FAQ under support tab.
- We reserve the right to amend any of the above without prior notice.
16. This warranty does not affect your statutory rights.

To register for your warranty, please visit:

www.arisitwarranties.com.au/Customer-Registration.aspx

or scan the QR code.



ARISIT PTY LIMITED (Australia)
ABN 23 091 515 294

40-50 Mark Anthony Drive
Dandenong South VIC 3175
P: Sales & Service: 1300 762 219
F: Sales & Service: (03) 9768 0838
E: arisit@arisit.com

ARISIT PTY LIMITED (New Zealand)

1A Howe Street Newton, Auckland 1145
PO Box 68-140 Newton, Auckland 1145
P: (09) 306 1020 - Fax: (09) 302 0077
E: sales2@aristonappliances.co.nz

www.arisit.com

www.siriusbrand.com

**6 Year
Warranty**

when Sirius ducting is used.

Full replacement warranty on parts and labour. Check website for T&Cs.

10 year warranty on SEM motors.

Sirius Hoods and ducting products are only available from our select group of Sirius Professional Stockists nationwide. For the latest list of Sirius Stockists near you, please refer to www.siriusbrand.com

All efforts have been made to ensure that the information provided in this brochure is correct at the time of printing. Due to continuous product improvement and ongoing development, Sirius reserves the right to make changes to the products and technical data without prior notice. Some products appearing in this brochure may be for illustrative purposes only. Diagrams are indicative measures only. Prior to commencing cabinetry cutouts the operating/installation instructions accompanying the product must be referred to at www.siriusbrand.com