



**Congratulations on your purchase!
Thank you for choosing a Sirius product.**

SL926DLTM series
TWIN MOTOR UNDERMOUNT RANGEHOOD
INSTALLATION INSTRUCTIONS

SL926DLTM850
SL926DLTM1000
SL926DLTM1200

EAN #9351116002800
EAN #9351116002817
EAN #9351116002824

SMART / *SWITCH*



BEFORE YOU INSTALL - DUCTING INFORMATION

Sirius warranty covers only Sirius product. If you choose to install a non-Sirius branded accessory such as flexible ducting, Sirius will only warrant the rangehood and motor. If installation is found to be the cause of failure or issue then charges will apply for service and parts.

Flexible ducting is not permitted under any circumstances. Flexible ducting has been found to increase noise levels, increase vibration and reduce airflow. Sirius Semi-rigid or solid ducting can be used in lieu. There is a range available to suit any application.



The appliance must be installed and connected to the power supply only by a qualified technician.

- There should be adequate ventilation of the room when the rangehood is used at the same time as appliances burning gas or other fuels (not applicable to appliances that only discharge the air back into the room)
- The details concerning the method and frequency of cleaning
- There is a fire risk if cleaning is not carried out in accordance with the instructions;
- Do not flambé under the range hood;
- CAUTION: Accessible parts may become hot when used with cooking appliances.

Ducting available at www.siriusbrand.com

6 Year Warranty when Sirius Ducting is used. Full replacement warranty on parts and labour. See website for terms & conditions.

A reduction in the duct diameter from stated ducting size will void warranty.

If you are in doubt about the ducting, please contact Sirius on 1300 762 219 prior to installation

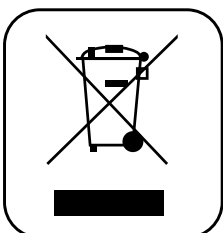

The symbol on the product or on its packaging indicates that this product may not be treated as household waste. Instead it shall be handed over to the applicable collection point for the recycling of electrical and electronic equipment. By ensuring this product is disposed of correctly, you will help prevent potential negative consequences for the environment and human health, which could otherwise be caused by inappropriate waste handling of this product. For more detailed information about recycling of this product, please contact your local city office, your household waste disposal service or the shop where you purchased the product. This appliance is marked according to the European directive 2002/96/EC on waste electrical and electronic equipment (WEEE).



Min. 600mm - Max. 750mm for induction cooktops.

Min. 650mm - Max. 750mm gas cooktops.

If the rangehood is positioned above the max height recommended, warranty may be compromised as performance of the rangehood will be affected. Measurement is taken from the top of the trivets to the underside of the hood. (Fig. 1)

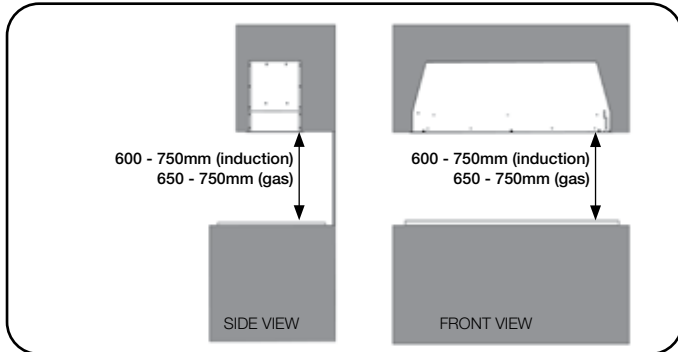

(Fig. 1)

- The air being drawn can't be conveyed through or into a duct used to let out fumes from appliances fed by energy other than electric power (eg. centralized heating, radiators, water heaters, etc.).
- Attention: remove any possible PVC film from the stainless steel, including the filters.
- To externally vent, please comply with the pertaining rules given by competent authorities.
- Provide the room with an adequate ventilation when a rangehood and appliances fed by energy other than electric power (gas, oil, or coal stoves, etc.) are used simultaneously. The rangehood, when evacuating the air, could generate a negative pressure in the room which can't exceed the limit of 0.04 mbar, in order to avoid the suck of exhausts deriving from the heat source. Therefore the room should be provided with air intakes to allow a constant flow of fresh air.

If the rating label in the rangehood shows the symbol , the appliance is built in class II° and it **does not need** any earth connection.

If the rating label in the rangehood does not show the symbol , the appliance is built in class I° and it **needs** the earth connection.

When performing the electrical connections on the appliance, please make sure that the current-tap is provided with earth connection and that voltage values correspond to those indicated on the label placed inside the appliance itself.

Before carrying out any cleaning or maintaining operations, the appliance needs to be switched off. If the appliance is not provided with a non-separable

flexible cable and plug, or with another device ensuring omnipolar disconnections from the grid, with an opening distance between the contacts of at least 3mm, then such disconnecting devices must be supplied within the fixed installation.

If the fixed appliance is endowed with a supply cord and a plug, the appliance has to be put in a place where the plug can be reached easily.

The use of materials which can burst into flames should be avoided in close proximity of the appliance. When frying, please pay particular attention to fire risk due to oil grease. Being highly flammable, fried oil is especially dangerous. Do not use uncovered electric grills. In order to avoid possible fire risk, all instructions for grease-filter cleaning and for removing eventual grease deposits should be strictly followed.

When ducting rangehood, options are as follows:

Roof vent - EASYROOF 200T/M

*Kit includes roof flashing

[Download installation guide](#)

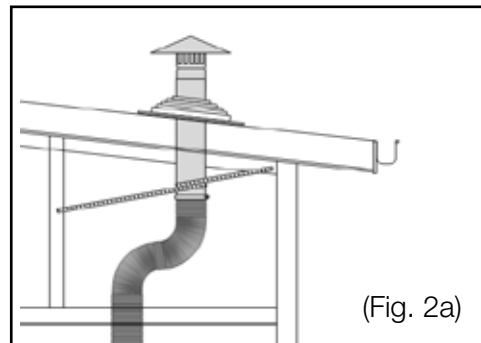

(Fig. 2a)

Eave vent - EASYEAVE 200

[Download installation guide](#)

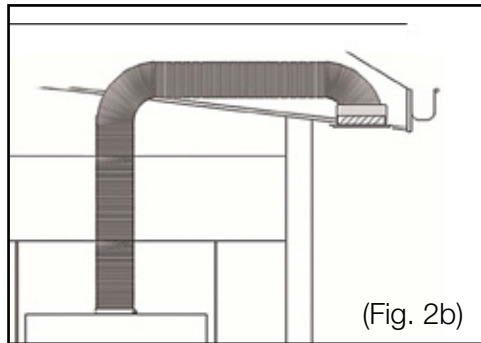

(Fig. 2b)

Wall vent - EASYWALL 200

[Download installation guide](#)

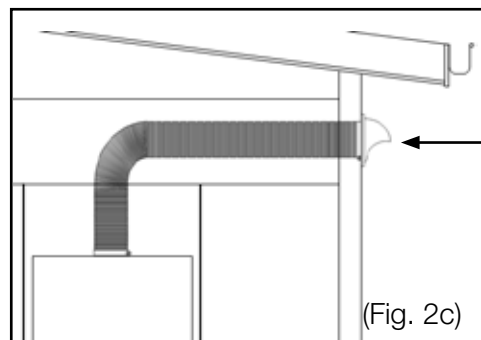

(Fig. 2c)

Dome featured on 200mm kit only

SL926DLTM series INSTALLATION - ONBOARD

WARNING: Failure to install the screws or fixing device in accordance with these instructions may result in electrical hazards.



Before installing the appliance, make sure that none of the parts are damaged in any way. In case of damaged parts, contact your retailer and do not proceed with installation. Read all of the following instructions with care before installing the appliance.

- Use ducting within the min/max specifications
- Limit the number of ducting bends.
- Do not make any changes in ducting diameter (recommended constant diameter: Ø 200 mm or equal surface area).

Before installing the appliance - in order not to damage the appliance itself - the metal grease filter should be removed. These filters could be removed by pushing the handles towards the back side of the rangehood and pulling it downwards to unfasten it from its slot. (Fig.3).

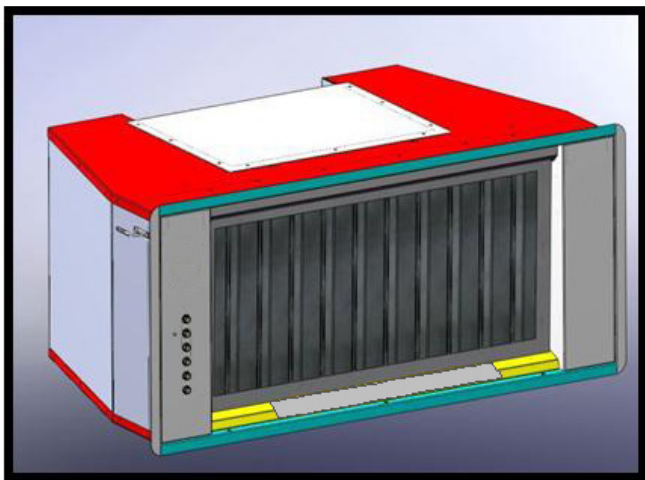

(Fig.3a)

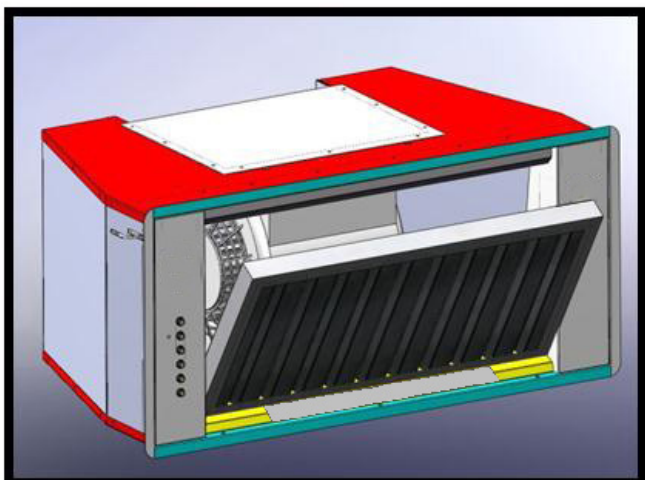

(Fig.3b)

To install the appliance please respect the follow instructions:

- The appliance must be installed by qualified technicians, or where possible use a Sirius recommended installer. See siriusbrand.com. In order to avoid damage to the electronic parts of the appliance, please do not use additional screws.
- Essential precautions to respect before installing the appliance are the following:
To have made a cutout on the bottom of the cabinet which is suitable to hold the appliance in position (fig. 4):

SL926DLTM 850 - 835 x 265mm

SL926DLTM 1000 - 985 x 265mm

SL926DLTM 1200 - 1100 x 265mm

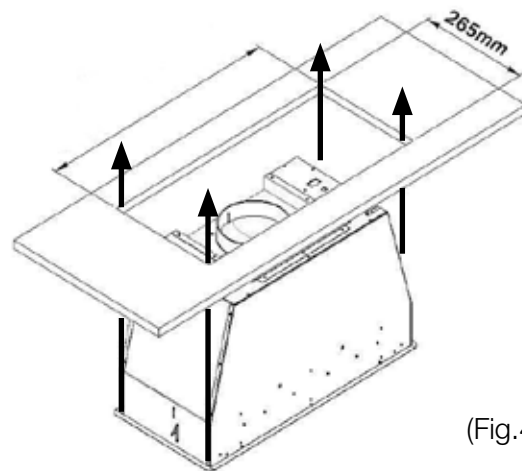

(Fig.4)

1. Prepare the power supply - 240 volts.
 2. Prepare a hole for the exhaust - 210mm for twin motor versions.
- Do not use screws to fix the ducting to the rangehoods as they will prevent the movement of non-return valves.
 - Limit the number of elbows in the ducting, since each elbow reduces the duct efficiency by 1 metre. (i.e. if you use two 90° elbows, the length of ducting must not exceed 5 metres.)
 - Avoid abrupt direction changes.
 - Use 200mm constant diameter for the whole length for the twin motor rangehood.
 - **The use of Sirius ducting will increase the warranty of the unit to 6 years.**

WARNING

The rangehood is quite heavy, so two people will be needed for installation.

1. To install the appliance, adjust the position of the adjustable side-springs using the supplied screws (fig.5), according to the thickness of the board, in which the appliance will be fixed.

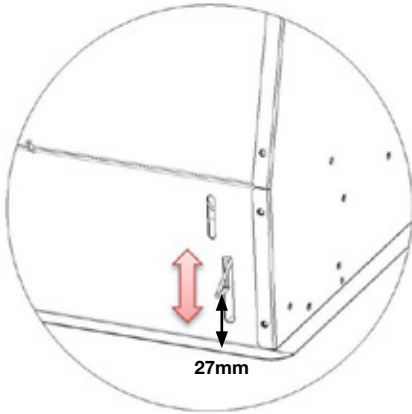

(Fig.5)

2. Insert the rangehood into the cutout in the cabinet until the stop click of the side-springs is heard and the rangehood is supported.
3. Insert the **25mm screws** provided into the holes inside the rangehood (Fig.6) to fix it to cabinetry.

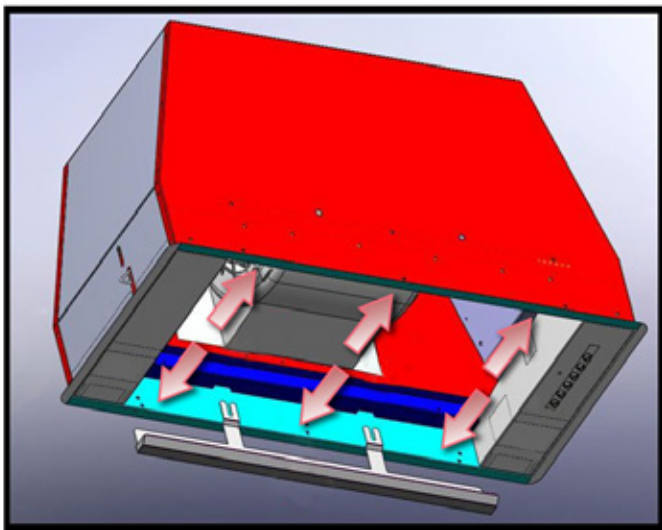

4. Insert the grease channel. (Fig.6)
5. Insert the grease filter (Fig.3b)

CAUTION

Before connecting any ducting to the motor, make sure the non-return valves - which are on the air outlet of the motor - can swing open.

External venting

- Connect the flange to the exhaust hole with the appropriate ducting. Connect the rangehood with the electrical mains through the supply cord.

OPERATION

SL926DLTM

- A: Light switch on/off
- B: Motor switch on speed 1/off - (low/simmer)
- C: Motor switch on speed 2 - (general cooking)
- D: Motor switch on speed 3 - (high power)
- E: Motor switch on speed 4 - (booster)
- F: 10 minute shut-off timer

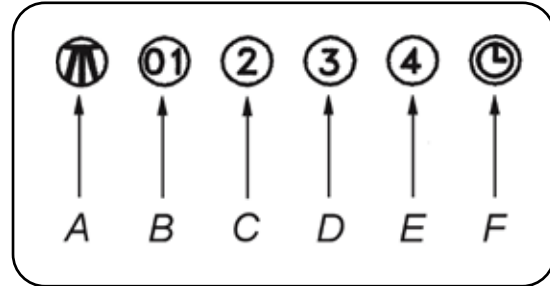

(Fig.11)

MAINTENANCE

- Accurate maintenance guarantees good functioning and long-lasting performance.
- Particular care is due to the grease filter panel. It can be removed by pushing its handle toward the back side of the rangehood and pulling the filter downwards so to unfasten it from its slot (Fig.3). To insert the filter just perform the opposite operation.
- After 30 hours of operation, the push button control panel will flash, signaling the filters are due for cleaning. Press the timer button to reset. ⌚ The grease filter needs cleaning by regular handwashing or in dishwashers every two months at least, depending on its use.
Filters may require cleaning sooner if frequent heavy frying is done.
- To clean the appliance itself, water and detergent are recommended, while abrasive products should be avoided. For steel appliances specialized detergents are recommended (please follow the instructions indicated on the product itself to obtain the desired results).

NOTE

To remove the rangehood from the cabinet, remove the fixing screws (fig. 6) using a screwdriver, and remove the grease filters (fig.3).

- Push down on the small handle of the springs, which are inside the rangehood, with the necessary strength to unhook the hood from the cabinet.

REPLACING THE LED LIGHT ON THE SL 926-DL

1. Before replacing the LED light, switch off the rangehood, then - by using appropriate tools - remove the LED light from its slot. (Fig 12a - b)
 2. Take out the LED light from its connector and replace. (Fig 12c - d)
- To find the correct LED light, please contact Sirius directly on our toll-free number: **1300 762 216**.
 - NB: light is easier to remove from the **centre of LED strip**. Use a small, flathead screwdriver, palette knife or blunt butter knife.



If the supply cord is damaged, it must be replaced by the manufacturer or its service agent or a similarly qualified person in order to avoid a hazard.

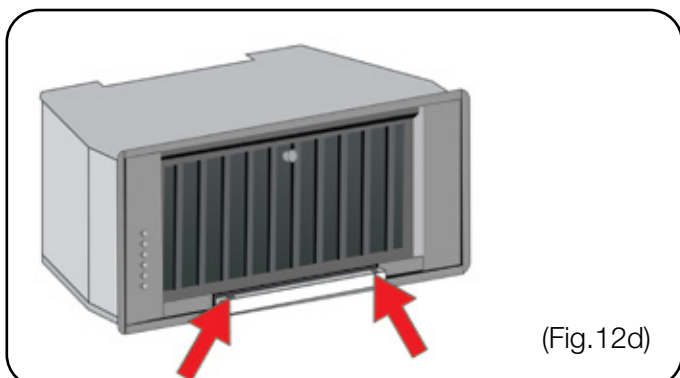
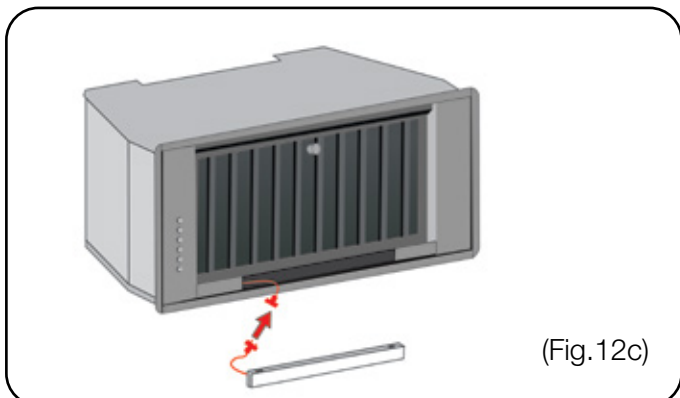
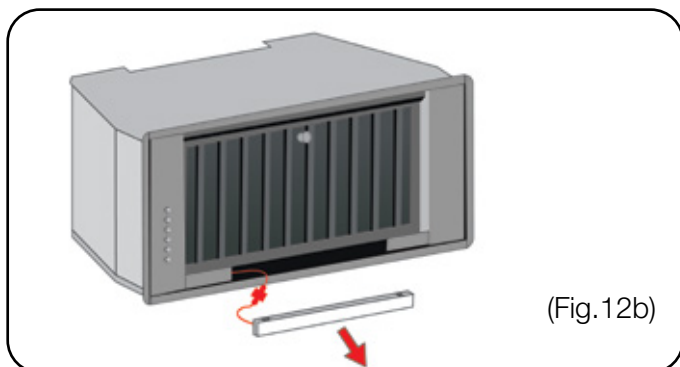
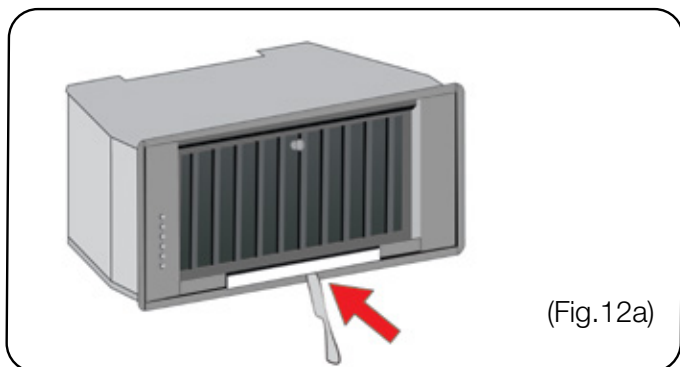

REMOTE CONTROL

SL926 DL

Working:

6 channel control for rangehood remote.

- When the rangehood is first turned on, hold the lighting button for 5 seconds.

TECHNICAL DATA

- Alkaline battery powered: 12 V mod. 23 A
- Operating frequency: 433.92 Mhz
- Combinations: 32.768
- Max. consumption: 25 mA
- Operating temperature: -20 ÷ + 55 °C
- Dimensions: 120 x 45 x 15 mm.

OPERATING THE REMOTE

The transmitter is equipped with 5 buttons as specified below:

- ☉ : Light ON/OFF.
- ⏻ : Motor ON (speed level 1) / OFF.
- : Reduce speed.
- + : Increase speed.
- ⌚ : 10-minute shut-off timer.

DEFAULT OPERATING CONDITION

The manufacturer supplies the remote control unit ready to be used with codes preset in the factory.



OPERATION MODE

Standard configuration:

Standard configuration requires all rangehood remote control systems to be provided with the same transmission code. In the event two rangehoods are installed in the same room or nearby, each system may affect the operation of the another. Therefore, the code of one remote control system must be changed.

Generating a new transmission code:

The system is provided with preset codes. Should new codes be required, proceed as follows: Press simultaneously buttons:



for two seconds. When LEDs are on, press buttons:

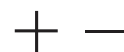

(within 5 seconds). The LEDs flash 3 times to indicate the procedure is completed.

WARNING! This operation deletes permanently the preset codes.

Learning the new transmission code.

Once the transmission code is changed in the remote control unit, the electronic central unit of the rangehood must be made to set the new code in the following way:

Press the red main power-off button of the hood and then restore power to the electronic control unit. Within the next 15 seconds, press the Light Button ☉ to synchronise the central unit with the code.

Reset of the Factory configuration:

To restore the Factory configuration, follow the procedure described below: press simultaneously buttons:



for 2 seconds. When LEDs light on, press buttons:



(within 5 seconds). LEDs flash 6 times to indicate the procedure is completed.

WARNING! This operation deletes permanently the preset codes.

Emergency button:

In the event that the remote control does not work, use the emergency button to switch the appliance off. After any necessary repairs have been performed, reset the emergency button.

WARNING

The battery should be replaced every year to guarantee the optimal range of the transmitter. To replace the battery, take the plastic lid off, remove the battery and replace it with a new one, making sure it is placed the correct way.

Used batteries should be discarded in special collection bins.

NOTE: The removal of the battery may cause the remote frequency to lose transmission with the rangehood. Follow the procedure on page 8 of the manual to generate the new code if this occurs.

The below product:

RC001 Remote Controls complies with the specifications set out in the Directive RED 2014/53/EU.

WARNING



Any adjustments or modifications which have not been expressly approved by the holder of the legal conformity certificate may invalidate the user's rights relating to the operation of the device.

The products are fitted with an electronic device which switches off the unit after 4 hours from the remote or manual buttons being used.



DIMMABLE LIGHT FUNCTION

This function provides for lights dimmability, ranging from 20% to 100%, by holding down light key on the remote control or rangehood buttons.

Functions are the following:

- rangehood light off- shortly press the key - light on a 100%
- light on at 100% - shortly press the  key - light off
- light on at 100% - hold down the light button  to reduce brightness.
- releasing the key during reduction, or increase - light keeps the luminous intensity reached.
- Light on - dimmed - hold down the light button to increase brightness.

COLOUR TEMPERATURE SETTING (KELVIN)

Ensure the lights and fan are turned off. Hold down the TIMER key  until the light turns on. Then hold down the LIGHT key  to cycle through from warm to cool or cool to warm depending on which kelvin it is set at previously. Once you have the desired light set, hold down the TIMER key  until the light turns off, this will save the colour temperature.

'BI-POWER' FUNCTION

The new Smart-Switch **BI-POWER** feature is designed to offer the user a rangehood with the option for significant energy saving and noise reduction, specifically for cooking that does not require high-powered extraction performances. Activating the **BI-POWER** feature increases the airflow power of the hood for when a more powerful extraction is required.

To activate the Bi-Power function, select a speed on the rangehood by pressing one of the buttons, and then hold that same button for 3 seconds. You should be able to hear the rangehood motor power change. To deactivate the function, press and hold the current speed setting for 3 seconds.

THE SIRIUS APP

DOWNLOAD SIRIUS APP FOR ANDROID

1. Open the Google Play Store App 
 2. Search or browse for SIRIUS App.
 3. Select it.
 4. Tap to Install.
 5. Follow the onscreen instructions to complete the transaction and get the content.
- You can change what language is displayed when you visit Google Play on your computer by changing your Google Accounts settings.
- Note: Apps are designed for use with supported Android and Chromebook devices and can't be used on Windows or Mac computers.

DOWNLOAD SIRIUS APP FOR iOS

Notes:

- After requesting an app, you may be asked to verify your identity by entering your passcode or by using Touch ID or Face ID.
 - The steps below don't apply to the iPhone 5c, iPhone 5, iPhone 4s or the iPhone 4.
1. Open the App Store 
 - To install apps, you must sign in with your Apple ID or create one.
 2. To browse the App Store, tap Apps (at the bottom).
 3. Tap Search (at the bottom) then enter SIRIUS App.
 4. Tap the app.
 5. Tap GET then tap INSTALL.
 - If you have a compatible iPhone with Face ID enabled, double-tap the Side button then look at the screen to authenticate.
 6. If prompted, sign in to the iTunes Store to complete the install

CREATE YOUR ACCOUNT ON SIRIUS APP.

1. From Home App, Tap on Join now.

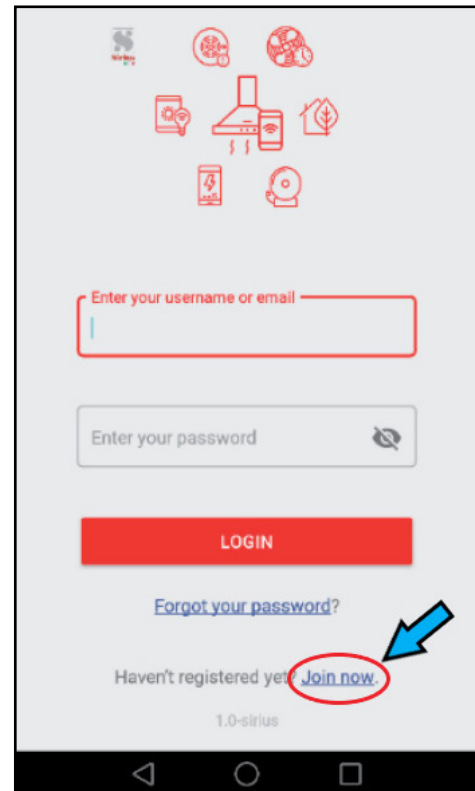

2. Insert your account data

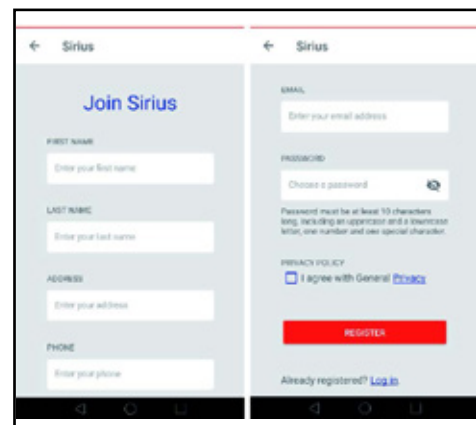

Tap Agree with General Privacy and tap on Register.

3. If all instructions are done correctly a Popup message **“Registration was successful. Check your email for the activation link”** appears.

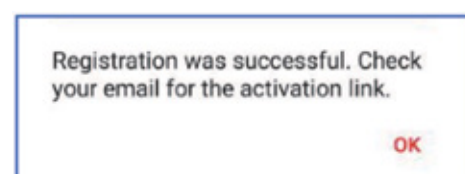

4. Go to your e-mail address and Confirm your account.

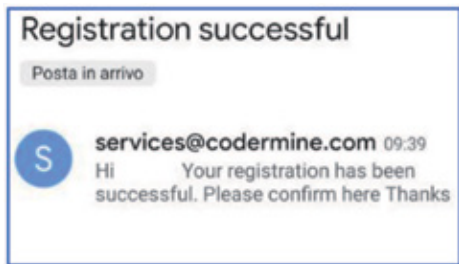

Note: We'll send the email from **service@codermine.com**, so you can quickly search for it. If it isn't in your inbox, check your folders. If a spam filter or email rule moved the email, it might be in the Spam, Junk, Trash, Deleted Items, or Archive folder. If you didn't find yet please create another account.

5. From Login page Insert the e-mail and password of your account and tap LOGIN.

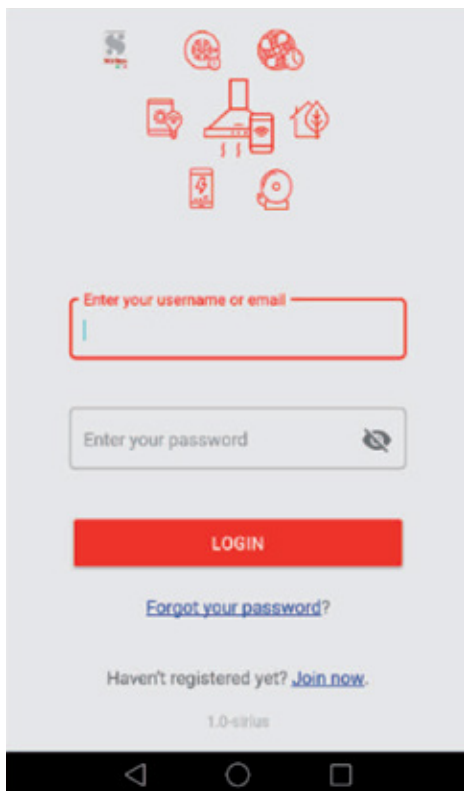

Note: If you forgot your password, tap on **Forgot your password?** insert your e-mail address and tap **Send me a Link.**

PAIRING YOUR PRODUCT

Fast way using the **WPS** procedure, if your router has no **WPS** button, please follow the next instructions.

PAIRING WPS MODE

1. After Login Tap the **☰** App Menu (top left) and select **DEVICES**.

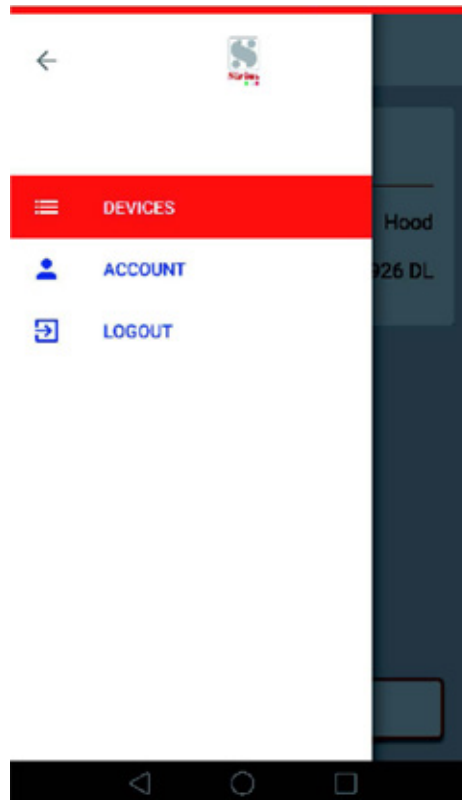

2. Tap **ADD NEW DEVICE**.

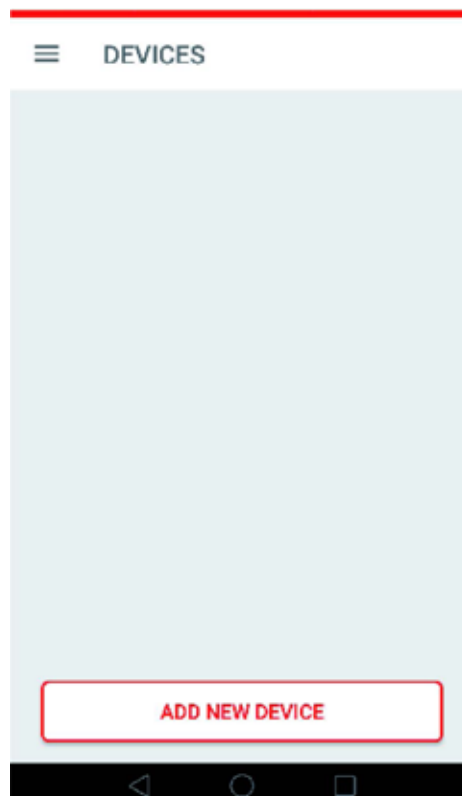

3. Tap USE WPS MODE.

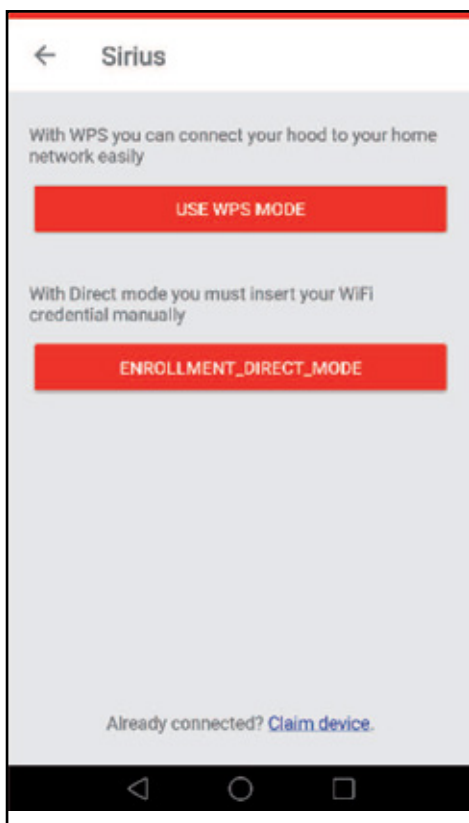

4. On your Router WI-FI press WPS button.



5. On your range hood:

- Switch off completely (light and motor)
- Hold (01) button for 3 sec for settings menu ((TV) (01) LEDs will flash)
- Press (2) button to enable WPS pairing.
- Hold (01) button for 3 sec to save.

Note:

If buttons are not pressed within 10 secs the system automatically exits from settings menu and all unsaved operations will be discarded.

6. Press DONE on WPS description.

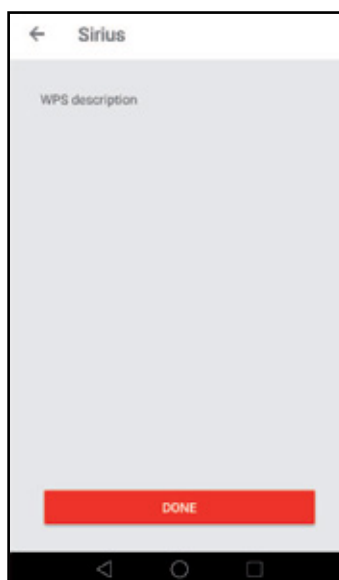

7. Use the QR code reader to connect the product with the App, using the label on the brochure or using the label located inside the product, found on the motor when you remove the grease filters.



8. Press ACTIVATE DEVICE and you have a pop-up message.

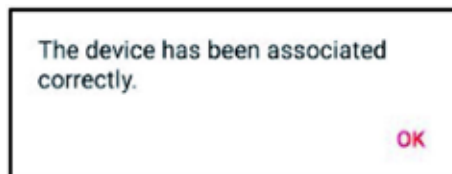

8. Tap the device icon. Enjoy your device.

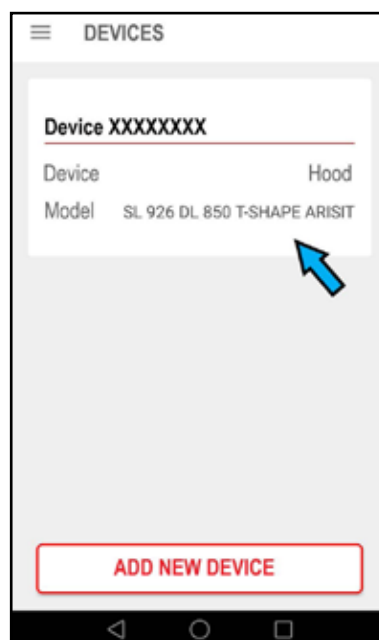

PAIRING MANUAL MODE

1. After **Login** Tap the **☰ App Menu** (top left) and select **DEVICES**

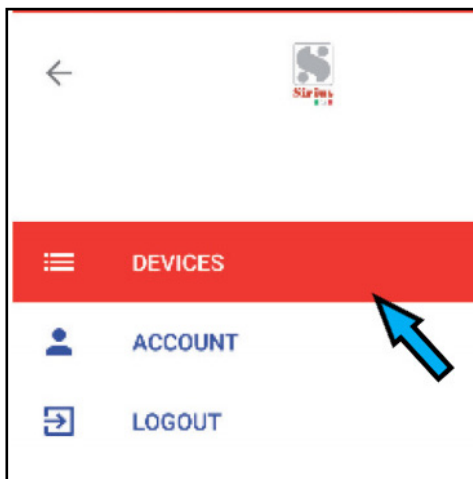

2. Tap **ADD NEW DEVICE**

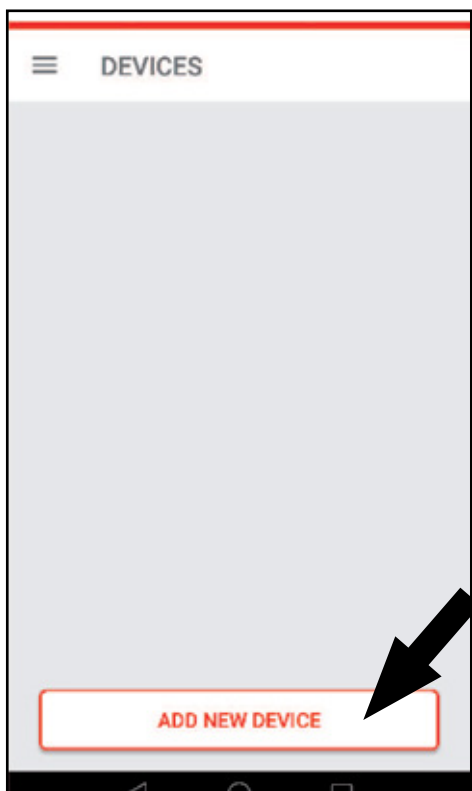

3. Tap **ENROLLMENT_DIRECT_MODE**



4. **ON YOUR RANGE HOOD:**

- Switch off completely (light and motor)
- Hold **01** button for 3 secs for settings menu (**01** LEDs will flash)
- press **03** button to enable manual pairing
- Hold **01** button for 3 sec button to save.

Note:

If buttons are not pressed within 10 secs the system automatically exits from settings menu and all operations unsaved will be discarded.

5. Tap **OPEN SETTINGS**

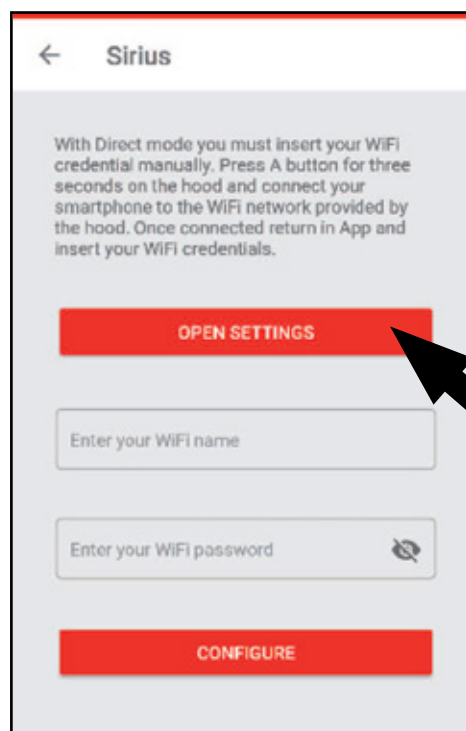

6. Connect to **“HOOD network”** inserting as passwork “password”.

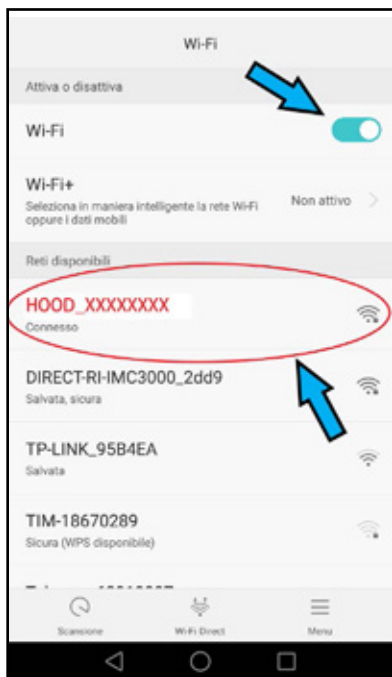

7. TURN BACK

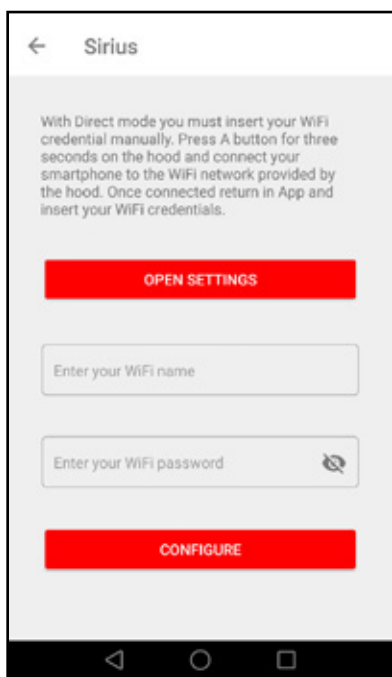

8. ENTER WI-FI NAME AND WI-FI PASSWORD
9. TAP CONFIGURE

10. In case of following error

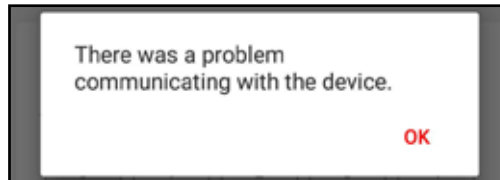
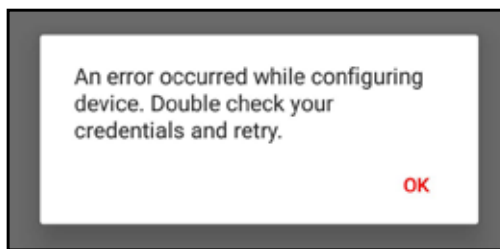

Go back to the home page.

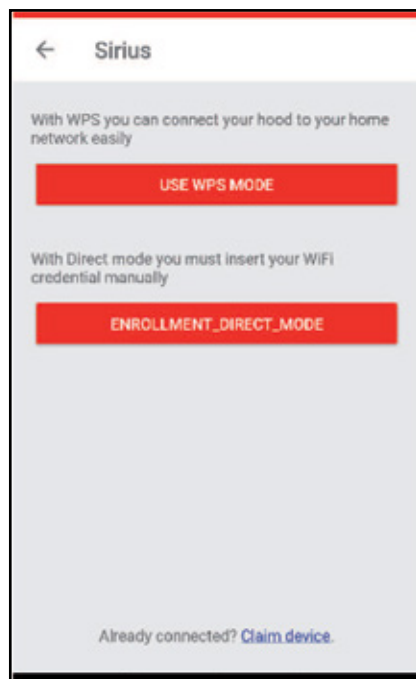

TAP **“Claim Devices”**.

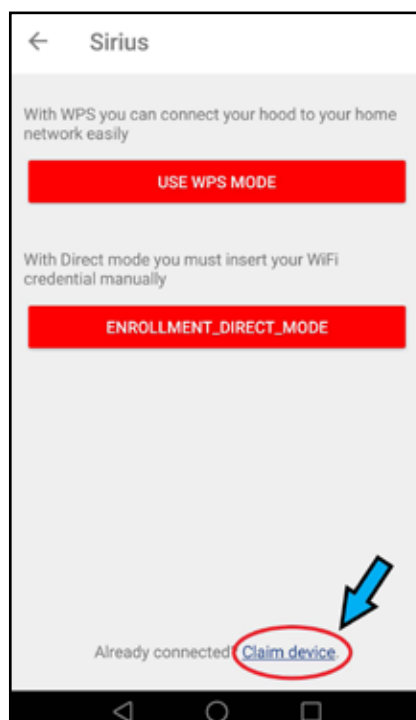

11. Use the QR code reader to connect the product with the App, using the label on brochure or using the label located inside the product, visible by removing the grease filters.



12. Connect your mobile to your home **Wi-Fi Router** network.

13. Press **ACTIVATE DEVICE** and you have a pop-up message.

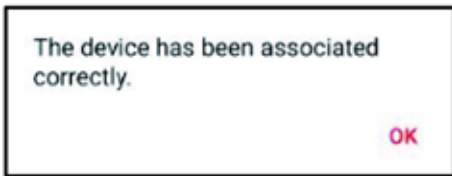

14. Tap the device icon. Enjoy your device.

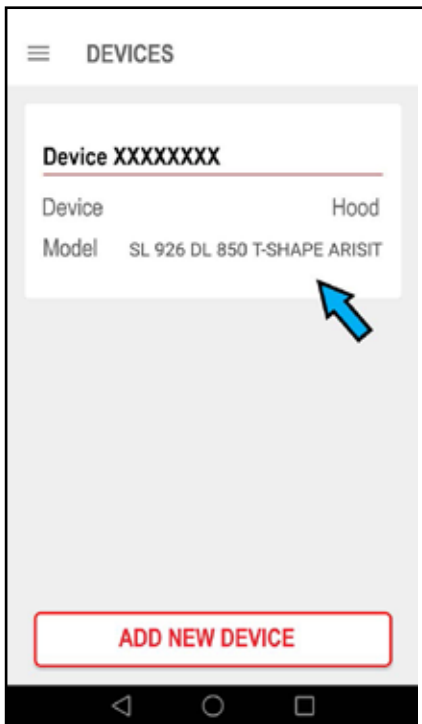

REMOVE ONE DEVICE FROM APP

1. After Login Tap the App Menu (top left) and select DEVICES

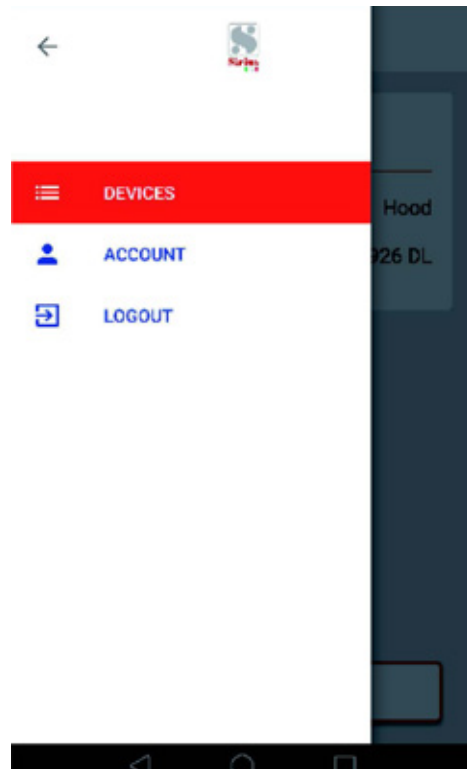

2. On **DEVICES** slice your device on left and tap **Remove**.

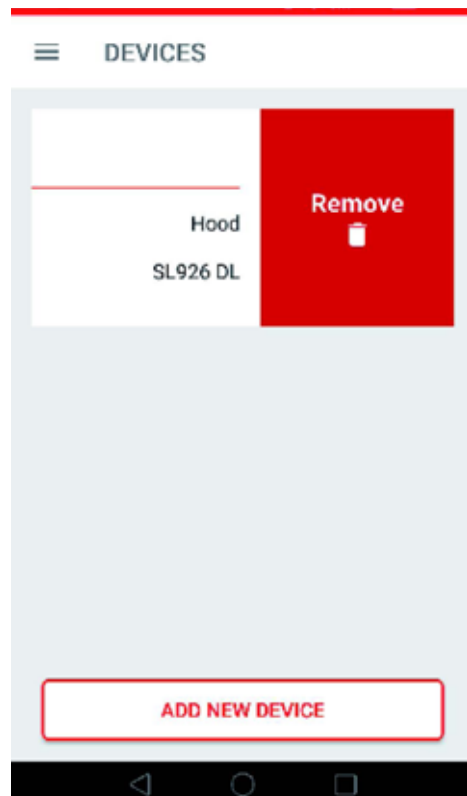

FUNCTIONS

Timer

Tap on  and set the minutes for shutting down the device.

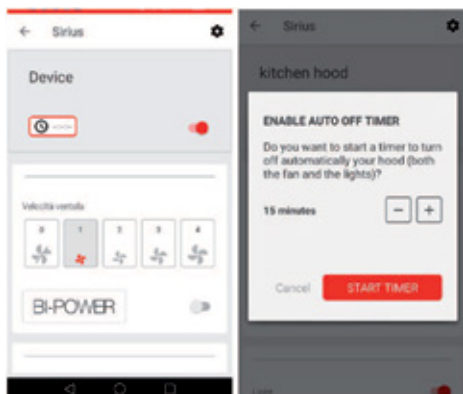

Fan speed

Tap on the speed you want, select '0' for switching OFF.



BI-POWER

The BI-POWER function allows reducing the performance of the fan, if the maximum efficiency of the product is not required.

LIGHT

Slide the toggle switch for switching ON/OFF.

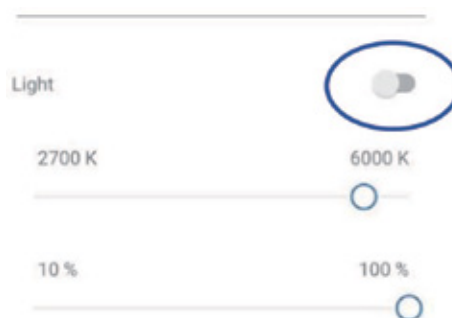

Slide the scrollbar for setting the colour temperature (°K)



Slide the scrollbar for lights dimmability, ranging from 10% to 100%.

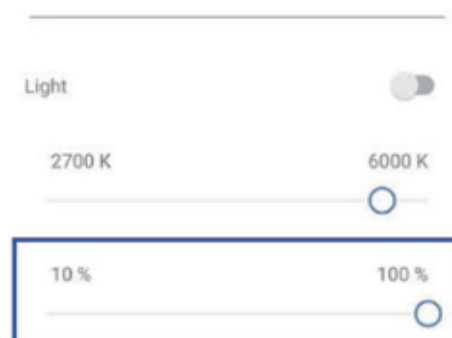

FILTERS CLEANING

 FILTER

Hours of use left before you need to provide maintenance.

 Filters
INOX

28h

RENAME DEVICE

Tap on  and rename device.

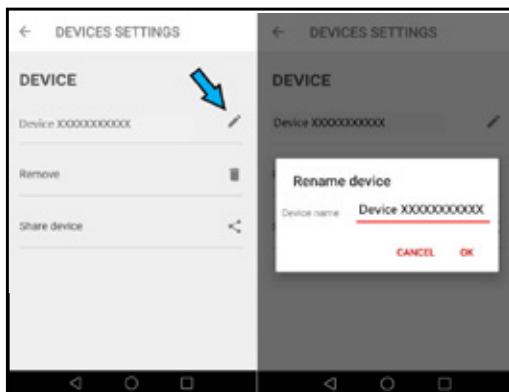
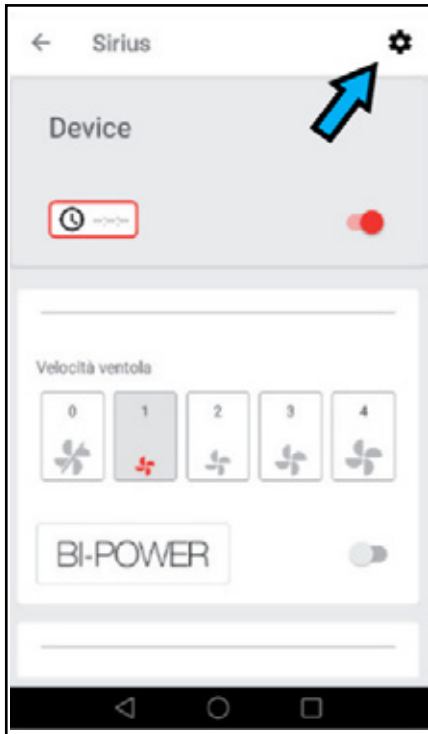

SHARE DEVICE

Tap on  and share device only to subscribed account.

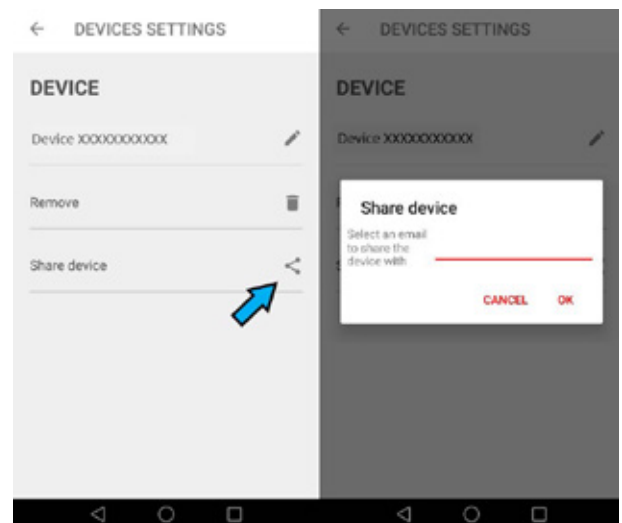
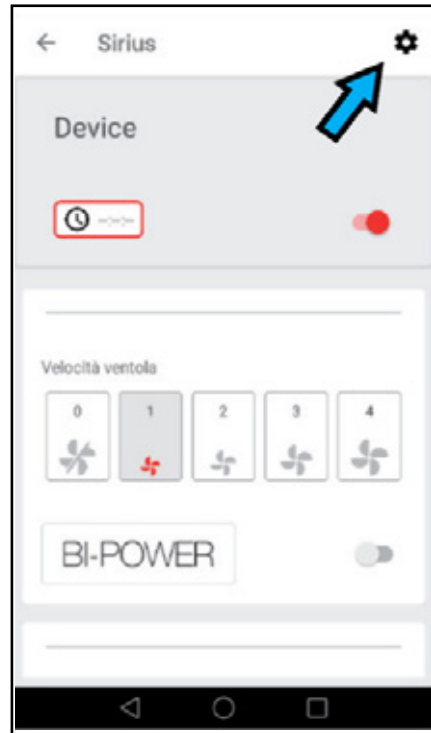

WIRING DIAGRAM: SL926DLTM

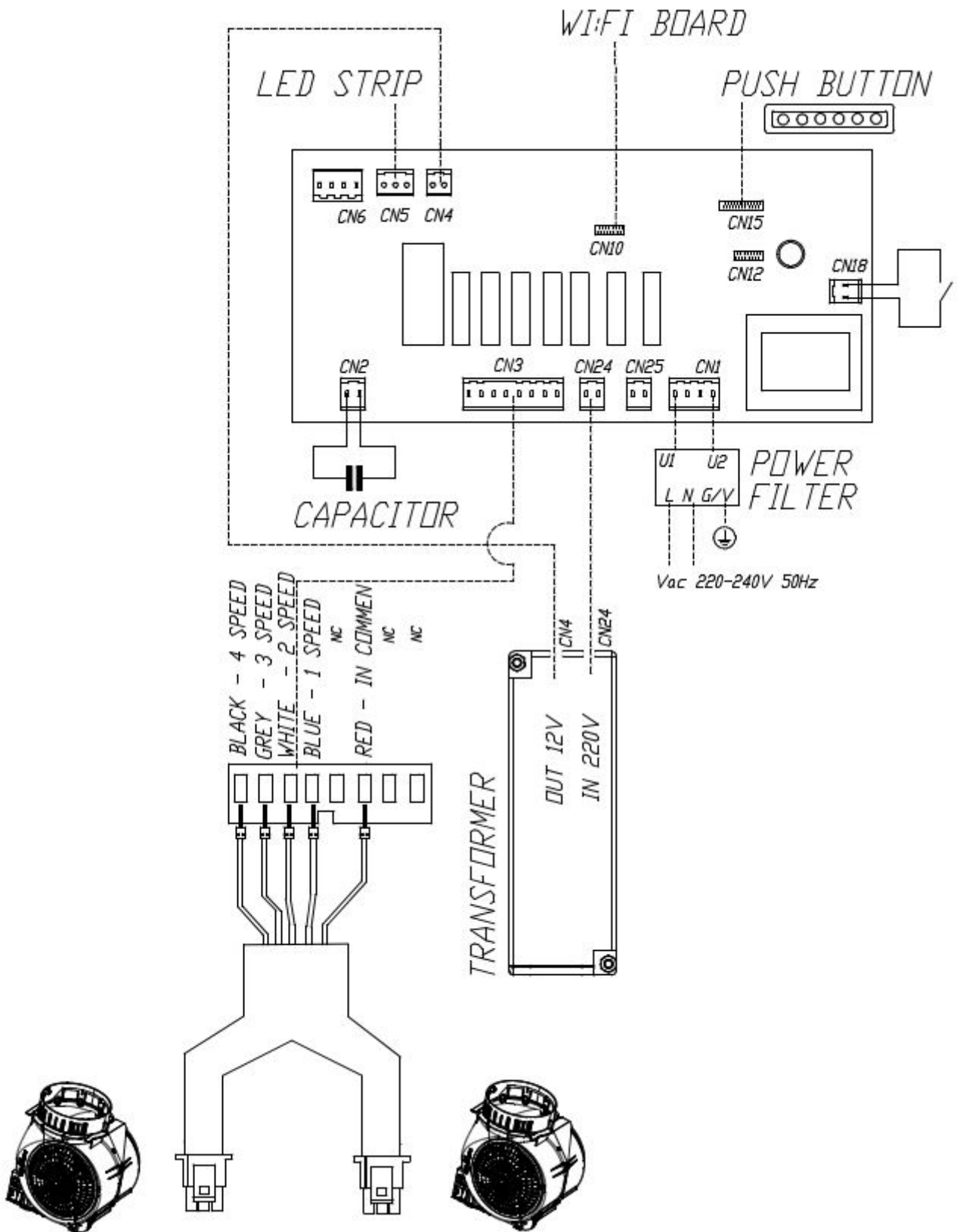

WARRANTY INFORMATION



Sirius

Dear Customer,

Thank you for choosing this Sirius Rangehood.

We are sure that it will provide you with many years of excellent service. At Arisit Pty Limited we are dedicated to ensuring that our customers receive the best possible after-sales care.

The Sirius 'Protection Plan' has been devised to give you added peace of mind. Should you encounter any problems with your appliance, our nationwide team of specially trained technicians will deal with your call swiftly and efficiently.

PRIORITY SERVICE, ACCESSORIES & SPARE PARTS

AUSTRALIA

ARISIT PTY LIMITED
40-50 Mark Anthony Drive, Dandenong South,
VIC 3175, Australia
Phone: 1300 762 219
Email: consumer.care@arisit.com

NEW ZEALAND

ARISIT PTY LIMITED
1A Howe Street, Newton,
Auckland 1145, New Zealand
Phone: (09) 306 1020
Email: sales@aristonappliances.co.nz

Warranty

By registering your ownership NOW, you qualify for Sirius's Total Peace of Mind Protection Plan.

Australian & New Zealand 3 / 6 Year Protection Plan*

This guarantees your appliance for a full 3 years parts and labour & 10 years for the off-board motors (covering manufacturing defects only) from the date of purchase, subject to the Terms and Conditions overleaf.

***3 Year warranty is extended to a 6 year period only when Sirius ducting is installed.**

 **Year Warranty**
when Sirius ducting is used*
www.siriusbrand.com

Your Warranty

Register now to qualify.

Terms & Conditions

These Terms and Conditions apply only to Sirius products distributed in Australia and New Zealand by Arisit Pty Limited.

1. This warranty applies for a period of 3 years on all products.
 - a) Warranty is extended to a 6 year period when Sirius ducting is installed.
 - b) All off-board motors are covered under warranty for a 10 year period for manufacturing defects only.
2. Warranty applies for parts and labour in Australia and New Zealand, commencing from date of purchase.
3. This warranty applies only to the original purchaser/hire purchaser of this appliance and cannot be assigned or transferred. Failure to produce documentary proof of the date of original acquisition by the original purchaser will result in a charge being levied for work done, labour and parts supplied.
4. This warranty does not apply to:
 - a) Consumable items such as filters, fuses, and light bulbs.
 - b) Damage to body work, paint work, glass, and plastic items (such as, but not limited to windows, covers, baskets, trays, worktops, door handles, control and kick panels.)
 - c) Corrosion & rust damage.

A fee may be charged following warranty claims where no fault is found with the appliance.

5. This warranty will not apply where:
 - a) The fault is caused by accident, misuse, an infestation of insect and or vermin, fire, flood or the use of products not approved by Arisit Pty Limited.
 - b) There has been a failure to comply with the manufacturer's operating and installation instructions.
 - c) Service, modification or repair has been carried out by anybody other than an approved Arisit Service Technician.
 - d) The appliance has been used/ installed anywhere other than a private dwelling, or where it has been used other than for domestic use.
 - e) The appliance is subject to a rental agreement.
6. Any defective part that has been replaced becomes the property of Arisit Pty Limited.
7. This warranty applies only to Sirius appliances purchased and installed in Australia and New Zealand.
8. Loss of use of the appliance or consequential loss of any nature is not covered.
9. A charge may be levied at the discretion of Arisit Pty Limited if the call is deemed unnecessary or if the cause of failure is traced to external sourced such as, but not limited to: blown fuses, power failure, faulty installation, customer misuse or negligence, etc
10. Where the appliance, the subject of a warranty claim or repair, is used or installed more than TWENTY (20) kilometres from the nearest Arisit Service Division or Authorised Service Agent, the cost of delivery to the nearest Service

Division or travel costs for a technician or Authorised Service Agent shall be for the account of the Purchaser. Where a built-in appliance is located or installed outside the Arisit Authorised Service Agent's normal service area, additional travel and labour costs shall be the account of the Purchaser.

11. Service is offered during normal business hours only, also appliances to have a clear access in a serviceable area
 12. Arisit Pty Limited shall not under any circumstances be responsible in terms of this warranty for the replacement or repair of any part of the equipment which may have been damaged in transit, during and after installation or imperfections after installation.
 13. Losses caused by act of God, failure to obtain spare parts, strikes or lockouts are not covered.
 14. External off board motors must be installed a minimum of 2 metres and maximum of 7 metres away from the rangehood. This is for optimum sound and performance.
 15. All motors must be accessible for servicing purposes and if installed above 2 metres from ground height additional cost will be incurred due to OH&S standards for service agents. Prior to install please check minimum & maximum installation details on the Sirius website, FAQ under support tab.
- We reserve the right to amend any of the above without prior notice.
16. This warranty does not affect your statutory rights.

To register for your warranty, please visit:

www.arisitwarranties.com.au/Customer-Registration.aspx

or scan the QR code.



ARISIT PTY LIMITED (Australia)
ABN 23 091 515 294

40-50 Mark Anthony Drive
Dandenong South VIC 3175
P: Sales & Service: 1300 762 219
F: Sales & Service: (03) 9768 0838
E: arisit@arisit.com

ARISIT PTY LIMITED (New Zealand)

1A Howe Street Newton, Auckland 1145
PO Box 68-140 Newton, Auckland 1145
P: (09) 306 1020 - Fax: (09) 302 0077
E: sales2@aristonappliances.co.nz

www.arisit.com

www.siriusbrand.com

**6 Year
Warranty**

when Sirius ducting is used.

Full replacement warranty on parts and labour. Check website for T&Cs.

10 year warranty on SEM motors.

Sirius Hoods and ducting products are only available from our select group of Sirius Professional Stockists nationwide. For the latest list of Sirius Stockists near you, please refer to www.siriusbrand.com

All efforts have been made to ensure that the information provided in this brochure is correct at the time of printing. Due to continuous product improvement and ongoing development, Sirius reserves the right to make changes to the products and technical data without prior notice. Some products appearing in this brochure may be for illustrative purposes only. Diagrams are indicative measures only. Prior to commencing cabinetry cutouts the operating/installation instructions accompanying the product must be referred to at www.siriusbrand.com