

SM924850

850MM ONBOARD UNDERMOUNT



SPECIFICATIONS

Rangehood Type	Undermount
GTIN	9351116002640
Country of Origin	Handcrafted in Italy
Designed to Suit	600-900mm GAS
Controls	Buttons
Speed Settings	4
Ducting Diameter	150mm
Recirculating	Optional (Not recommended - Please see website for more info)
Extraction Type	Onboard Motor
Motor	Single Aluminium Motor
Extraction Rate	800m ³ /hr
Filter Type	2x Internal Aluminium Filter
Noise Level	45dBa(min) to 70dBa(max)
Lighting	2 x 5W Led Strip
Run-on Timer	No
Electrical Requirement	10A
Max Current (W)	235W
Product Dimensions (mm)	W850 x D290 x H270
Cut-Out Dimensions (mm)	W835 x D265
Weight	18kg
Warranty	3 Years (6 years when Sirius ducting is used)

KEY FEATURES



Single Aluminium Motor

Performance and quiet efficiency are the most important elements in the performance of your Sirius hood. Sirius has worked tirelessly to create a product that ticks all the boxes.



Aluminium Mesh Filters

Easy to install and maintain, but it also provides superior filtration capabilities. Designed with a special deep pleat design that helps capture cooking odours before they enter the room.



Powerful Extraction

With a maximum airflow of 800M³/H, this rangehood quickly and effectively removes smoke, steam, heat, odours, and other airborne particles from areas requiring ventilation.



2 x 5W Led Strip

Energy-efficient with prolonged lifespan. Ideal for eco-conscious homes, providing quality illumination and minimizing replacement expenses.



Hand Crafted In Italy

Sirius Rangehoods, a prestigious Italian brand founded in 1996, is renowned for its bold designs and commitment to premium materials and craftsmanship, making it a top choice for high-end rangehoods.

LINE DRAWING

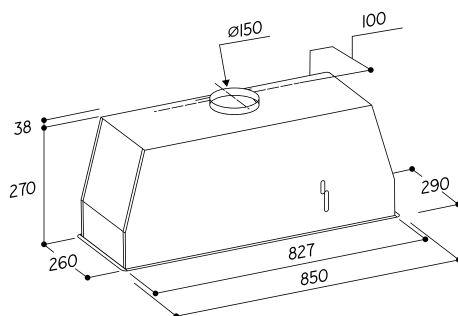

DISTRIBUTED BY ARISIT PTY LTD

40-50 Mark Anthony Drive, Dandenong South VIC 3175
Ph: 1300 762 219 Fax: 03 9768 0838 Website: www.arisit.com