

SL-EM 4190X 90CM WALL CANOPY HOOD

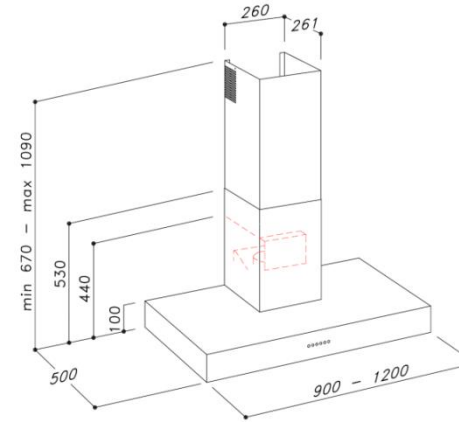





OFF BOARD MOTOR	Locating the motor away for the hood minimises noise in the kitchen up to 95% while still achieving maximum extraction, Motors can be installed up to 7 meters away with both indoor and external motors available making these the most versatile units on the market, no additional power required as motor is powered by a cable from the hood
HALOGEN LIGHTS	Energy efficient, Better illumination of cooking area, Longer life span than standard globes, Modern aesthetic
10MM COMMERCIAL STAINLESS STEEL BAFFLE FILTERS	Commercial design, Dishwasher safe, Designed for greatest air movement for maximum performance, Easy to fit and remove, Lifetime filters: last the life of the hood
INDUCTION COUNTDOWN CONTROL	10 minute auto function used at the end of cooking to reduce condensation build up common to induction cooking. 'C' shaped baffles eliminates moisture dripping onto cooking surface
LARGER DUCTING DIAMETER	Greater extraction and lower dB rating due to less air flow restriction
CLEAN FILTER INDICATOR	Takes the guessing game out of maintaining your hood
MADE IN ITALY	Units are designed specifically for the Australian market and manufactured in Italy by dedicated boutique specialist manufacturer

MODEL	CONTROL PANEL	MOTOR	EXTRACTION	DUCTING DIAMETER	LIGHTS	FILTER	ELECTRICAL REQUIREMENT	dB RATING	PRODUCT DIMENSIONS
SL EM4190X	ELECTRONIC CONTROL	SEM1 SEM2	1200m/3h 1200m.3h	150mm	2x 20W HALOGEN	10mm STAINLESS STEEL BAFFLE	10A	N/A	900 x 500 x 670 - 1090





RECOMMENDED DUCTING FOR INSTALLATION



SEMI RIGID DUCTING INSTALLATION – 150mm WALL VENTED

	SRPL30-150 12MM GAUGE SEMI RIGID DUCTING - 3 METER LENGTH
	GDC-150 INTERNAL DUCT CONNECTOR REQUIRES MINIMUM x 1 (TO CONNECT HOOD TO DUCTING) ADDITIONAL REQUIRED 1 x PER EXTRA 3M DUCT
	URC25-215 (PAIR) UNIVERSAL RING CLAMPS USED TO CONNECT DUCTING TO EXTERNAL VENT
	VENTS: SDV-150 (RAIN DOME, WALL) SLV-150 (FIXED ROUND LOUVRE VENT, WALL OR UNDER EAVE)

SOLID DUCTING INSTALLATION – 150mm WALL VENTED

	GP10-150 GALV STEEL SOLID DUCTING - 1 METER LENGTH GP12-150 GALV STEEL SOLID DUCTING – 1.2 METER LENGTH
	GDC-150 INTERNAL DUCT CONNECTOR REQUIRES MINIMUM x 2 (TO CONNECT DUCTING TO HOOD AND VENT) ADDITIONAL REQUIRED 1 x PER EXTRA DUCTING LENGTH
	easyFIT BEND OPTIONS (SELF CONNECTING, NO INTERNAL DUCT CONNECTOR REQUIRED): GE45-150 45° ELBOW – GALVANISED STEEL GE90-150 90° ELBOW – GALVANISED STEEL
	VENTS: SDV-150 RAIN DOME, WALL SLV-150 FIXED ROUND LOUVRE VENT, WALL OR UNDER EVE

SOLID DUCTING INSTALLATION – 150mm THROUGH ROOF VENTED

	GP10-150 GALV STEEL SOLID DUCTING - 1 METER LENGTH GP12-150 GALV STEEL SOLID DUCTING – 1.2 METER LENGTH
	GDC-150 INTERNAL DUCT CONNECTOR REQUIRES MINIMUM x 2 (TO CONNECT DUCTING TO HOOD AND ROOF COWL) ADDITIONAL REQUIRED 1 x PER EXTRA DUCTING LENGTH
	easyFIT BEND OPTIONS (SELF CONNECTING, NO INTERNAL DUCT CONNECTOR REQUIRED): GE45-150 45° ELBOW – GALVANISED STEEL GE90-150 90° ELBOW – GALVANISED STEEL
	ROOF FLASHING (SILICONE SOFT FORMING ALUMINIUM – 25 YEAR GUARANTEE): MRF-G102 SUITABLE FOR METAL ROOF TRF-G075 SUITABLE FOR TILED ROOF
	GRC-150 ROOF COWL – GALVANISED STEEL

HINTS AND TIPS ON DUCTING

- The less bends the better the extraction and quieter your hood will be
- Inferior ducting such as PVC, air con ducting and flexible ducting will void your warranty and reduce the efficiency of your hood
- easyFIT connections on Sirius ducting eliminates the need for riveting or taping joints
- For easyKIT options refer website / brochure
- For best results with installation, use only a Sirius preferred installer. Refer website for details

WARRANTY - All Sirius hoods come with a total peace of mind 3 year warranty covering parts and labour.

- Using Sirius branded ducting will increase your warranty to **4 years**
- All off board motors come with a full 10 year warranty
- We highly recommend hood installation by a qualified and preferred installer. A list of these installers can be located on our website.
- Incorrect or inferior installation will result in voiding your warranty.
- Please refer to product installation instructions supplied with the hood
- Go to www.arisitwarranties.com to register your product

CONTACT

Arisit Pty Ltd:

ABN: 23 091 515 294

40-44 Mark Anthony Drive

Dandenong South, VIC 3175

Ph: Sales and Service: 1300 762 219

W: www.siriuisbrand.com