

1000mm ONBOARD UNDERMOUNT RANGEHOOD - TWIN MOTOR

SL906-L EXCEL 1000

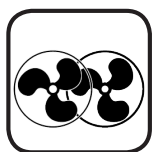

Rangehood type	Undermount
Control	Button
Speed settings	4
Ducting diameter	200mm
Extraction type	Onboard motor
Motor	Twin aluminium motor
Extraction	2000m ³ /h
Filter	25mm stainless steel baffle
Lighting	14W LED strip
Induction Countdown Control	Yes
Electrical requirement	10A
Noise level	57dBA
Dimensions (mm)	W1000 x D290 x H350
Cut-out dimensions (mm)	W980 x D265
Warranty	3 years (6 years when Sirius ducting is used)



TWIN MOTOR



25mm BAFFLE
FILTERS

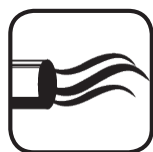

2000m³/h
AIRFLOW



INDUCTION
SAFE



LED
LIGHTING



HANDCRAFTED
IN ITALY

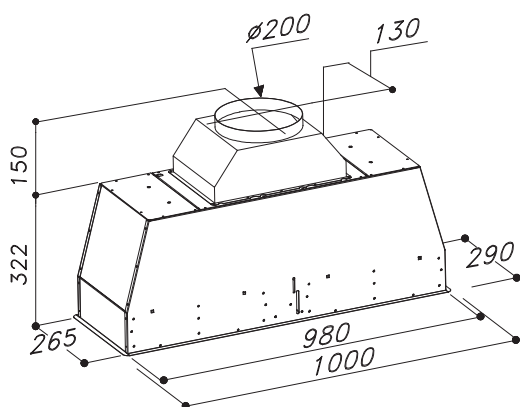

*Product dimension includes trim

Ducting options

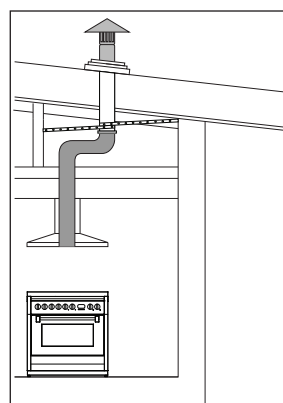

Roof ducted

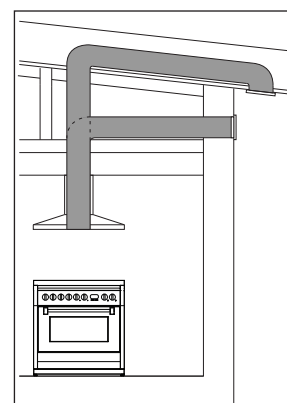

Eave or Wall ducted

- Use semi-rigid or rigid ducting, not fully flexible foil ducting.
- Fewer bends means a quieter and more powerful extraction.
- Extra 3 years warranty when Sirius ducting is used (total 6 years).
- See [support page](#) on Sirius website for installation videos and FAQs.

WARNING: technical specifications and product sizes can be varied by the manufacturer, without notice. Cut outs for appliances should only be by physical product measurements. The above information is indicative only.

Distributed by Arisit Pty Ltd

40-50 Mark Anthony Drive, Dandenong South VIC 3175

Ph: 1300 762 219

Fax: 03 9768 0838

Website: www.arisit.com

www.siriusbrand.com