

GB INSTALLATION, USE AND MAINTENANCE INSTRUCTION

SL51 fresco 1200 – SL35 fresco 1200
SL53 excel 900 – SL7 900 – SL7 1200 – SL19 900
SL22 900 – SLCR 83 – SL_EM41 – SLTC53 120
SLTC-EM53 90

TECHNICAL INFORMATION

TYPE: FSLA-FSLB-FSLC-FSLD



GB



The symbol on the product or on its packaging indicates that this product may not be treated as household waste. Instead it shall be handed over to the applicable collection point for the recycling of electrical and electronic equipment. By ensuring this product is disposed of correctly, you will help prevent potential negative consequences for the environment and human health, which could otherwise be caused by inappropriate waste handling of this product. For more detailed information about recycling of this product, please contact your local city office, your household waste disposal service or the shop where you purchased the product. This appliance is marked according to the European directive 2002/96/EC on waste electrical and electronic equipment (WEEE).

CONTENTS

GB

Warnings

Uses

Installation

Working

Maintenance

WARNINGS

“This appliance is not intended for use by persons (including children) with reduced physical, sensory or mental capabilities, or lack of experience and knowledge, unless they have been given supervision or instruction concerning use of the appliance by a person responsible for their safety. Children should be supervised to ensure that they do not play with the appliance.”

* The cooker surface and the inferior part of the cooker hood must be at a minimum distance of 65 cm.

* The air sucked can't be conveyed through or into a duct used to let out fumes from appliances fed by energy other than electric power (eg. centralized heating, radiators, water-heaters, etc.).

* To evacuate the air outlet, please comply with the pertaining rules given by competent authorities.

* Provide the room with an adequate aeration when a cooker hood and appliances fed by energy other than electric power (gas-, oil-, or coal- stoves, etc.) are used simultaneously. The cooker hood, when evacuating the sucked air, could generate a negative pressure in the room- which can't exceed the limit of 0.04 mbar, in order to avoid the suck of exhausts deriving from the heat-source. Therefore the room should be provided with air-intakes to allow a constant flow of fresh air.

If the rating label in the cooker-hood shows the symbol  , the appliance is built in class II° and it does not need any earth connection.

If the rating label in the cooker-hood does not show the symbol  , the appliance is built in class I° and it needs the earth connection.

* When performing the electrical connections on the appliance, please make sure that the current-tap is provided with earth connection and that voltage values correspond to those indicated on the label placed inside the appliance itself.

* Before carrying out any cleaning or maintaining operations, the appliance needs to be removed from the electric grid. If the appliance is not provided with a non-separable flexible cable and plug, or with another device ensuring omnipolar disconnections from the grid, with an opening distance between the contacts of at least 3 mm, then such disconnecting devices must be supplied within the fixed installation.

If the fixed appliance is endowed with a supply cord and a plug, the appliance has to be put in a place where the plug can be reached easily.

* **The use of materials which can burst into flames should be avoided in close proximity of the appliance. When frying, please pay particular attention to fire risk due to oil grease. Being highly inflammable, fried oil is especially dangerous. Do not use uncovered electric grills.**

* **Do not flambé under the range hood.**

In order to avoid possible fire risk, all instructions for grease-filter cleaning and for removing eventual grease deposits should be strictly followed.

CAUTION: Accessible parts may become hot when used with cooking appliances.

USES

The appliance is already arranged both for filtering and for suction performances.

* In its **filtering version** (Fig.1), the air and fumes conveyed by the appliance are depured both by a grease filter and by an active coal filter, and put again into circulation through the side-grids of the chimney. For this version an air deflector placed on the superior part of the pipe and allowing air-recycling is necessary (Fig.1A).

* In its **sucking version** (Fig.2), fumes are directly conveyed outside, through an evacuation duct connected with the superior part of the wall or the ceiling. Both coal filter and air deflector are not necessary in this case.

INSTALLATION

Before installing the appliance, make sure that none of the parts is damaged in any way. In case of damaged parts, contact your retailer and do not proceed with installation.

Read all of the following instructions with care before installing the appliance.

– Use an air outlet pipe of the shortest possible length.

– Limit the number of pipe bends.

– Use a material approved by standards and regulations.

– Avoid any sudden changes in pipe section (recommended constant diameter: 150 mm or equal surface area).

* Before installing the appliance, in order not to damage the appliance itself, the metal grease filter should be removed. Such filter can be removed by pushing the special filter handle toward the back side of the cooker hood and turning it downwards so to unfasten it from its slot (Fig.3B).

Wall stirrup-fixing

* By using the special drilling jig (Fig.4X), perforate the wall according to the pattern indicated by the jig itself, and pay attention in order not to damage water pipes and electric wires. Perforation should be performed with a □ 8 mm wall-drill. Then insert into the proper plastic reinforcements (Fig. 4A). The hood-bearing stirrup (Fig. 4S) can be applied by using the screws provided with the equipment (Fig. 4B). Now hook the cooker hood onto its bearing (Fig. 5) and then adjust horizontally and vertically the position of the appliance by acting on the special metric screws (Fig. 6V,T).

After the appliance is adjusted, fix it by inserting and tightening the safety screws properly (Fig. 4C).

WARNING: Failure to install the screws or fixing device in accordance with these instructions may result in electrical hazards.

Connection external motor version.

In external motor version it is necessary to connect the cable of the external motor to the corresponding connection in the hood.

If the connection from the external motor has two plugs, it is necessary to remove the cover of the bipolar connection before installation.

Fixing the ornamental chimney

* Before fixing the chimney, place the electric feeding equipment into the ornamental pipe and provide it with a hole for the air outlet if the appliance is used in its sucking version.

Warning!

Before connecting the flexible exhausting pipe to the motor, make sure the stop valve, which is on the air outlet of the motor, can swing.

Sucking version

* Fix the pipe-bearing stirrup (Fig. 7Y) to the wall or ceiling by using the proper reinforcements and screws in equipment. Connect the cooker-hood flange with the evacuation hole by using a proper pipe.

Put down the lower pipe while paying attention it is being properly introduced into the hood. Perform the electrical connections. The superior end of the pipe is to be fixed laterally to the pipe bearing (Fig. 8Y) by using the two self-threading screws. Now mount the inferior chimney by inserting it through the front side of the cooker hood and then turning it down until it is fixed inside (Fig. 8).

Filtering version

* In the filtering version the air deviator is fixed through the screws supplied (Fig. 9), by using the holes which are on the back of the upper telescopic section. Connect the flange of the appliance with the air deviator through an appropriate pipe. Connect the appliance with the electric mains. Connect it to the display cable strap. Put down the lower pipe while paying attention it is being properly introduced into the hood.

Fix the upper chimney as indicated in bic. 8.

WORKING

Mod. SL – Module – Luxury version (Fig. 13)

- A: Light switch on/off
- B: Motor switch on/off (1st rate level)
- C: 2nd rate level switch
- D: 3rd rate level switch
- E: 4th rate level switch
- F: 10-minute timer.

Mod. SL TC – Touch Control version (Dis. 14)

- A: Light switch On/Off
- B: Reduce speed
- C: Luminous telltale
- D: Increase speed
- E: 10 – minute timer

The touch control key allows the function desired by touching the relative key. The luminous telltales (C) positioned at the center of the keyboard indicate the suction speed set. In case of an active timer, the upper telltale (C) flashes.

If the push button console malfunctions, remove the grease filters and press the red button inside the appliance twice.

If the electrical power supply to the product SLTC is cut, 15 seconds are needed for self-diagnostics after the functions are restored. In the meanwhile, its operation may be incorrect.

MAINTENANCE

* An accurate maintenance guarantees good functioning and long-lasting performance.

* Particular care is due to the **grease filter panel**. It can be removed by pushing its special handle toward the back-side of the cooker hood and turning the filter downwards so to unfasten it from its slot (Fig.3B).

To insert the filter just perform the opposite operation.

After 30 hours working, the push button control panel will signal the saturation of the grease filter by lighting all the buttons. In the SLTC models (Touch Control Version) the grease filter saturation is signalled by the flashing of the two central push buttons (Fig. 14C). Press the timer button to reset ⌚.

The grease filter needs cleaning by regular hand-washing or in dishwashers every two months at least or depending on its use.

There is a fire risk if cleaning is not carried out in accordance with these instructions.

* In case the appliance is used in its filtering version, the **active coal filter** (Fig. 10) needs to be periodically replaced.

The coal filter can be removed by removing the grease filter first (Fig. 10B), and by pulling its special plastic tongue until it is unfastened from its slot. Re-insert the coal filter by operating in the opposite way. The coal filter needs replacing depending on the use, but however every six months at least.

* To clean the appliance itself tepid water and neutral detergent are recommended, while abrasive products should be avoided. For steel appliances specialized detergents are recommended (please follow the instructions indicated on the product itself to obtain the desired results).

* Before replacing the lamps, disconnect the appliance from the electric mains. Remove the grease filter and the carbon filter, if it is inserted. Once the burnt out bulb is localized, turn it anticlockwisely and replace it with a bulb of the same type.

* To replace the **halogen lamps**, remove first the glass-blocking ring (Fig. 11A), by levering with a screw-driver and thus removing the opaque glass (Fig. 11B) - when performing this operation hold the opaque glass carefully. Remove the lamp (Fig. 11C) without touching it with uncovered hands. Replace it with another lamp of the same kind. After the replacement, re-insert the glass-blocking ring and fasten it.

To replace the **dichroic lamp**, remove the lamp (Fig. 12) by inserting a screwdriver or another sharp tool between the lamp and its chrom support and replace it with a lamp of the same kind.

* If the supply cord is damaged, it must be replaced by the manufacturer or its service agent or a similarly qualified person in order to avoid a hazard.

WIRING DIAGRAM SL - EM41

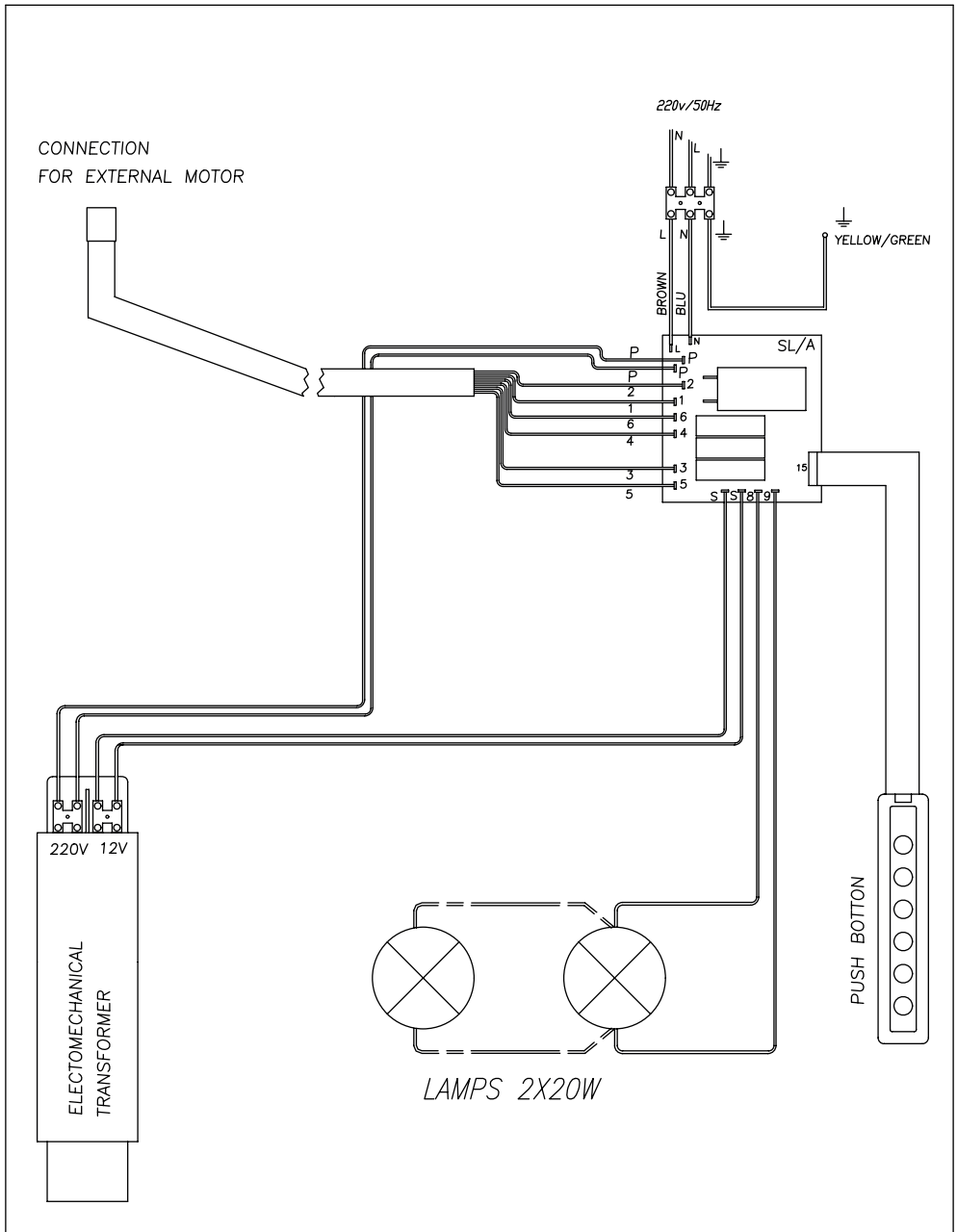

WIRING DIAGRAM SL2 - SL19 - SL22

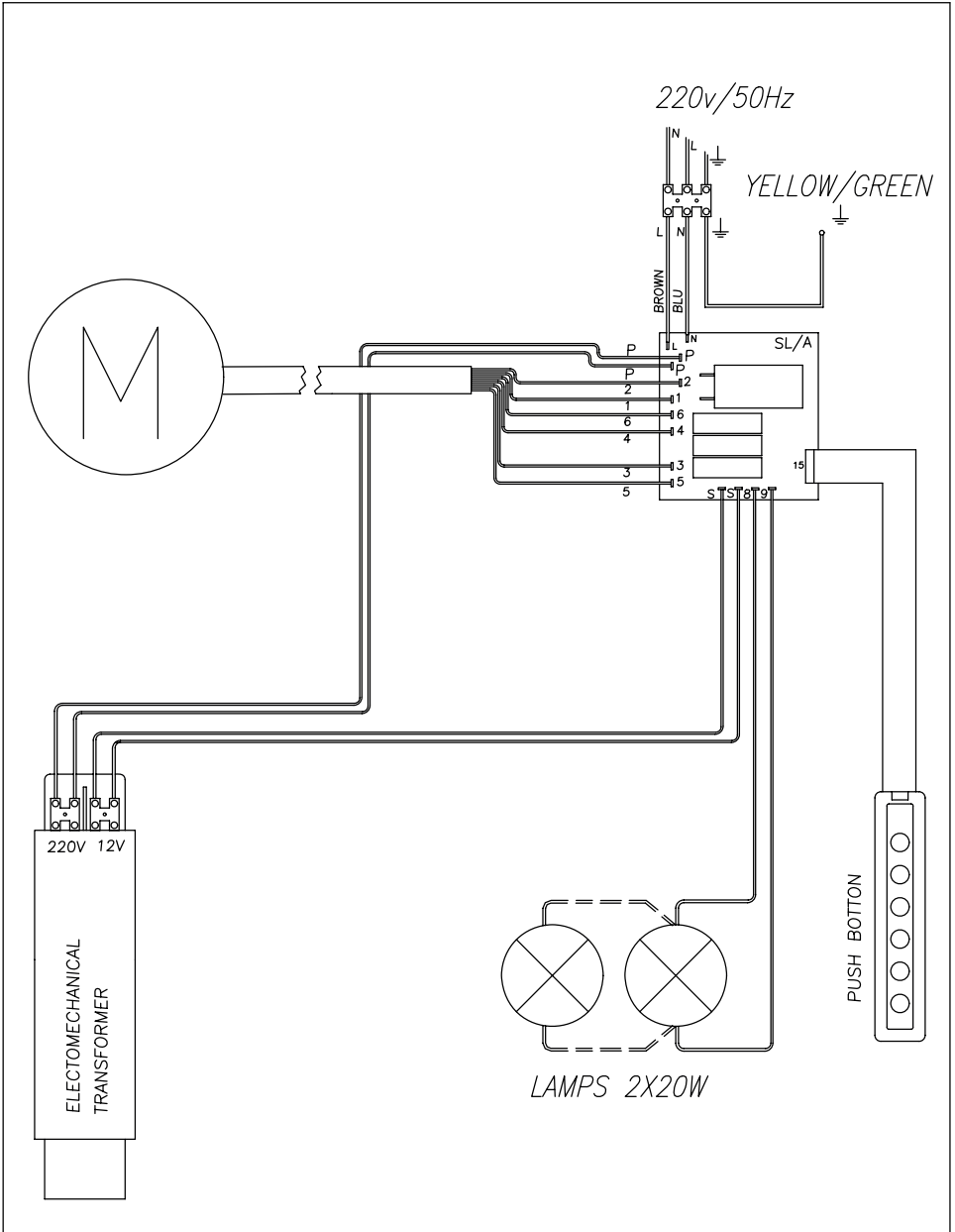

WIRING DIAGRAM SL-EM53

ONLY FOR SEM7
EXTERNAL MOTOR

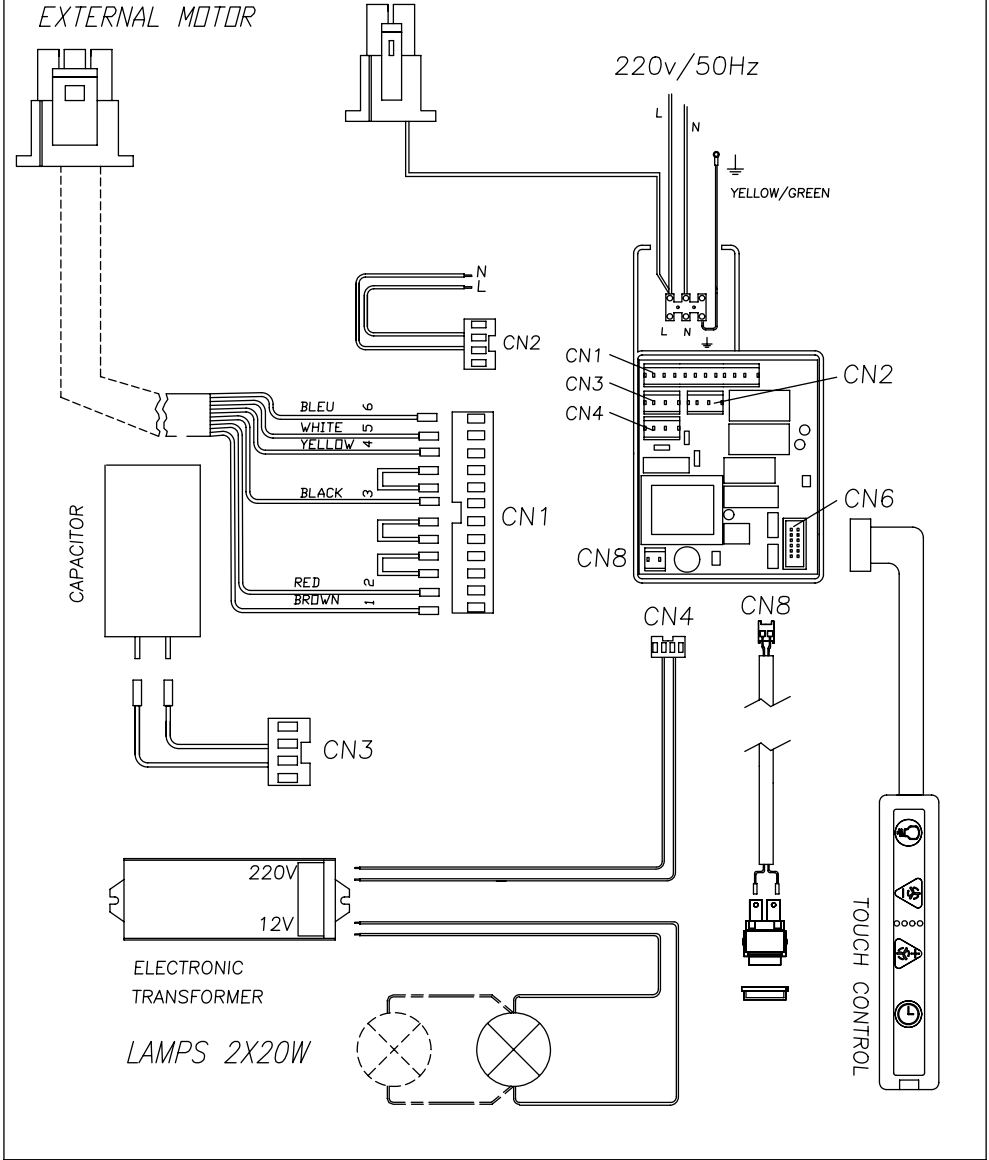

WIRING DIAGRAM SLTC53 2M

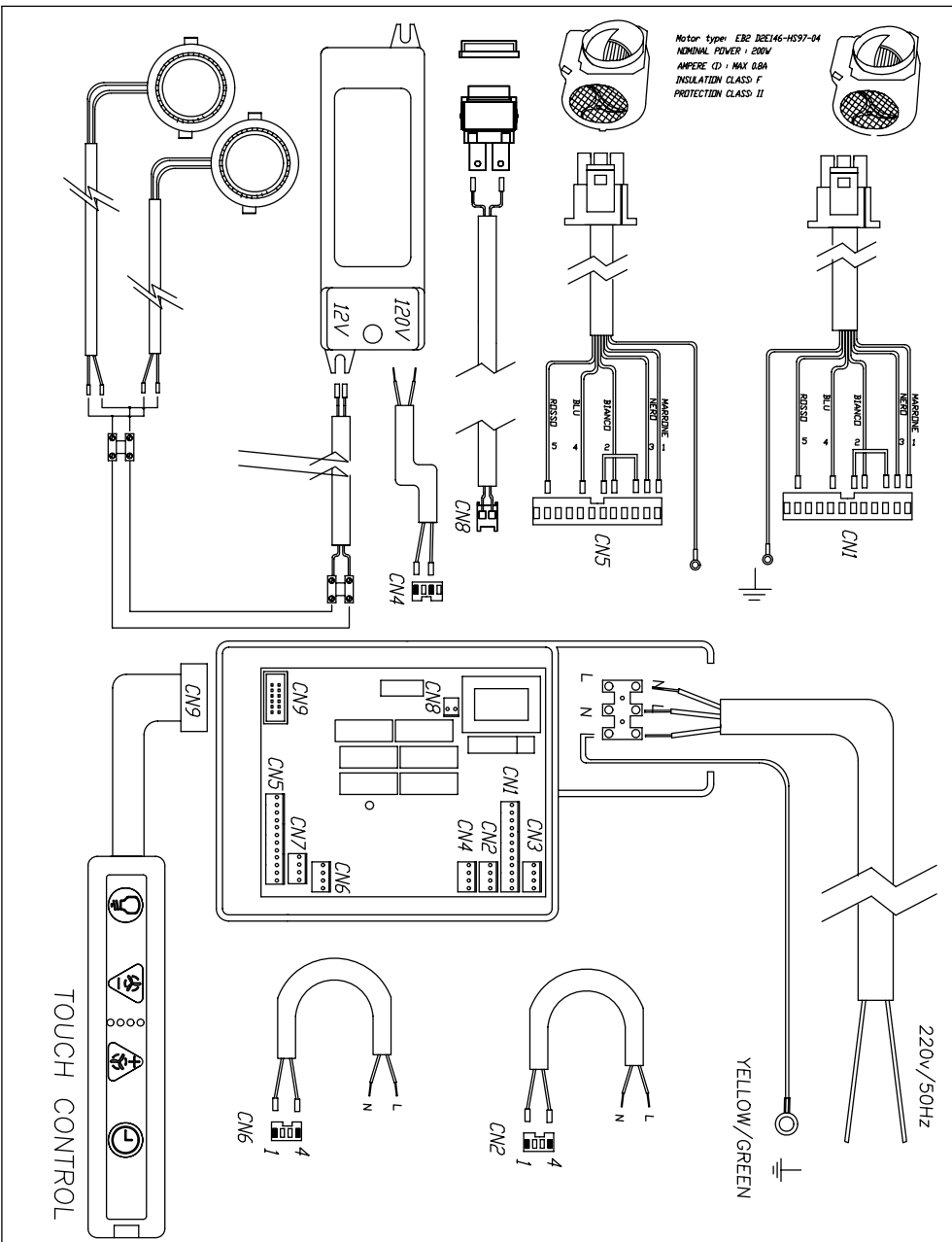

WIRING DIAGRAM SL47-P SL7

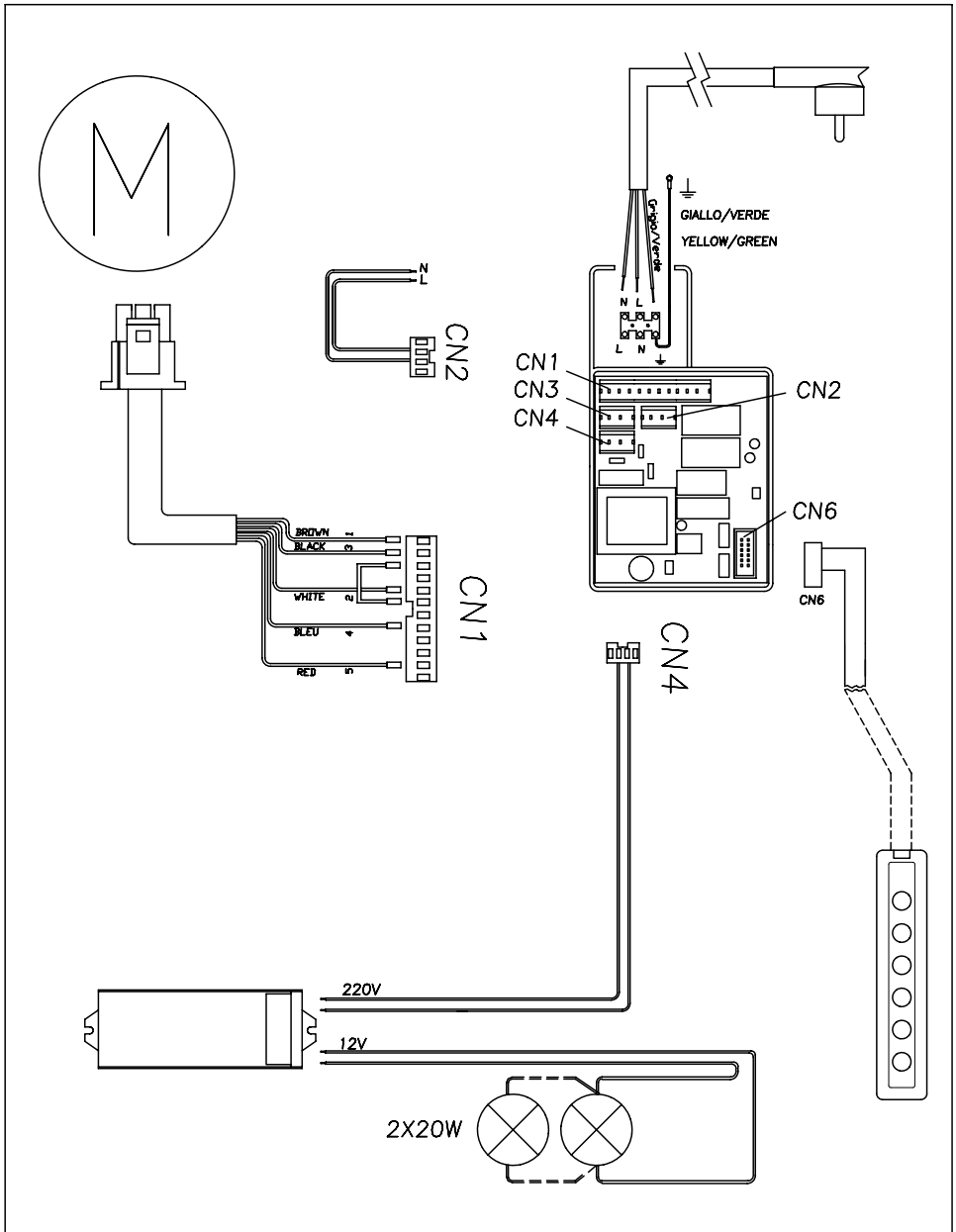

WIRING DIAGRAM SI906 2motors
WIRING DIAGRAM SL 51 2motors

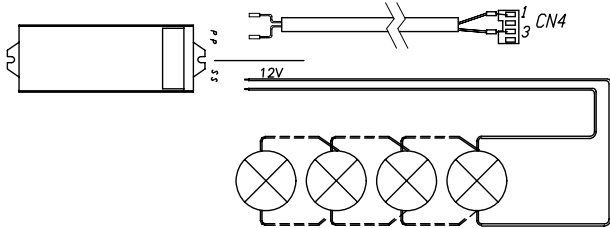
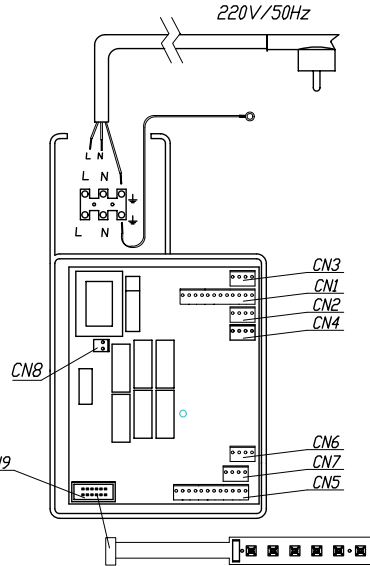
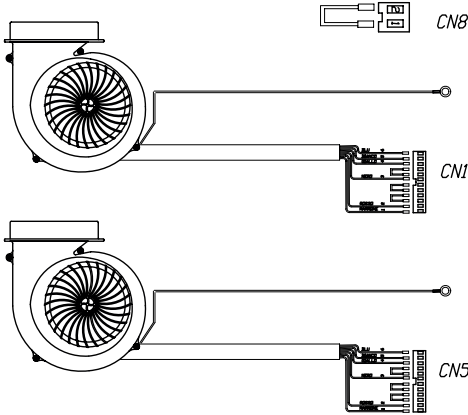
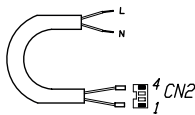
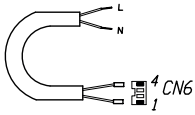
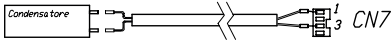
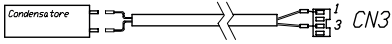

WIRING DIAGRAM SL906 2motors
 WIRING DIAGRAM SL 51 2motors
 WIRING DIAGRAM SL 53 2motors

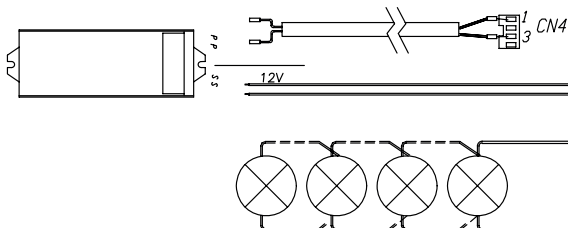
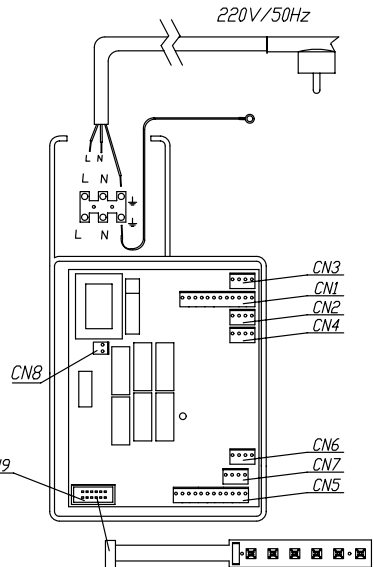
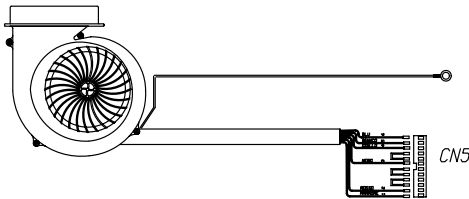
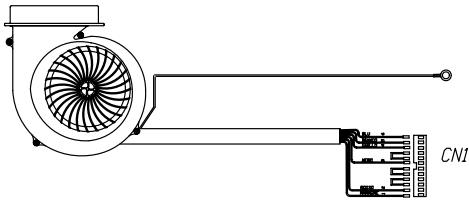
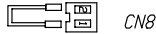
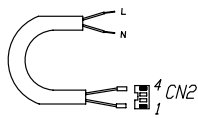
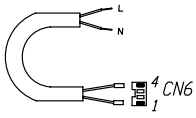
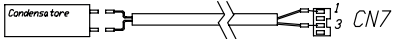
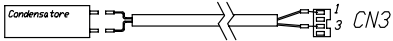

WIRING DIAGRAM SLCR35 48"

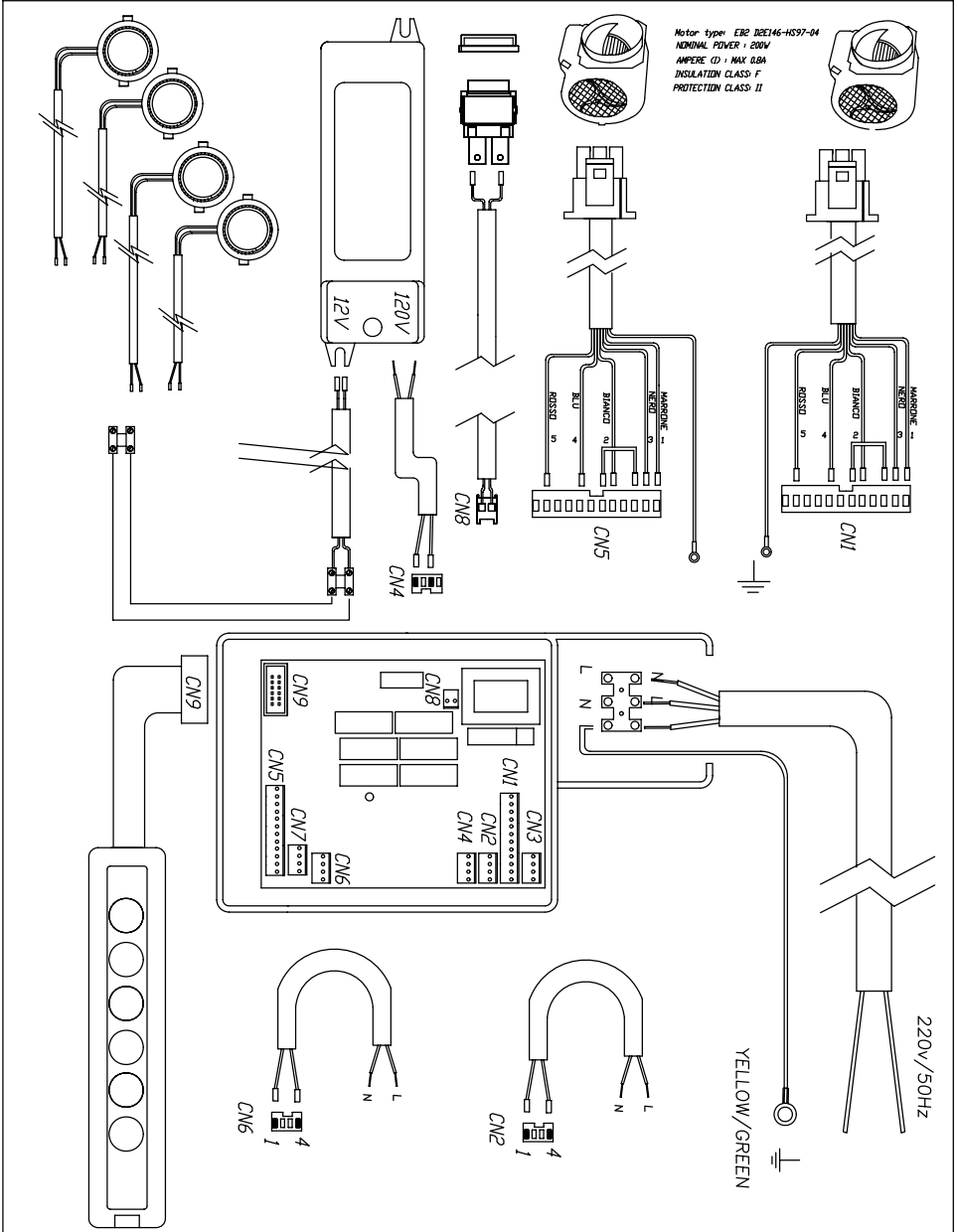

WIRING DIAGRAM SL83 cm120

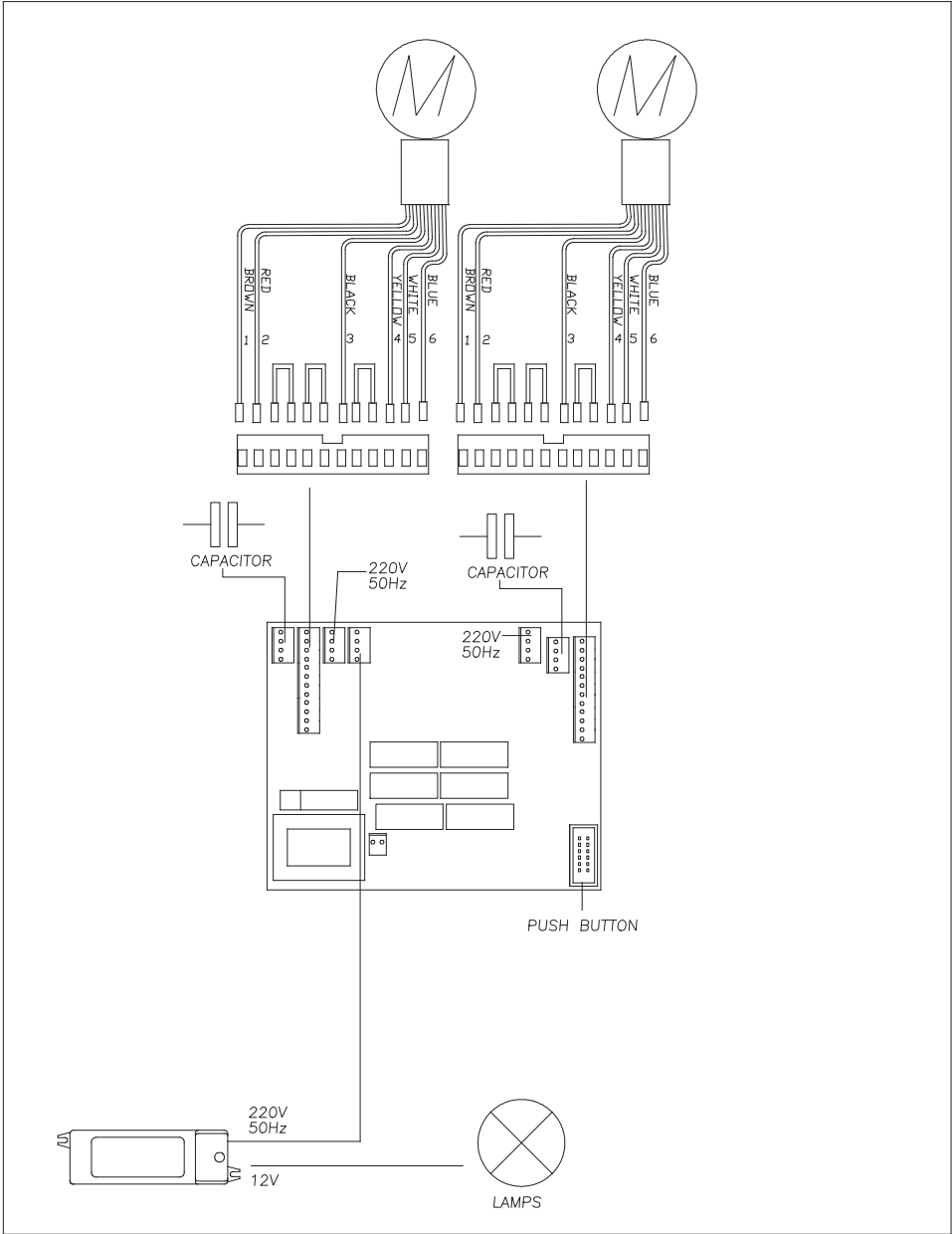

WIRING DIAGRAM SL83 cm150

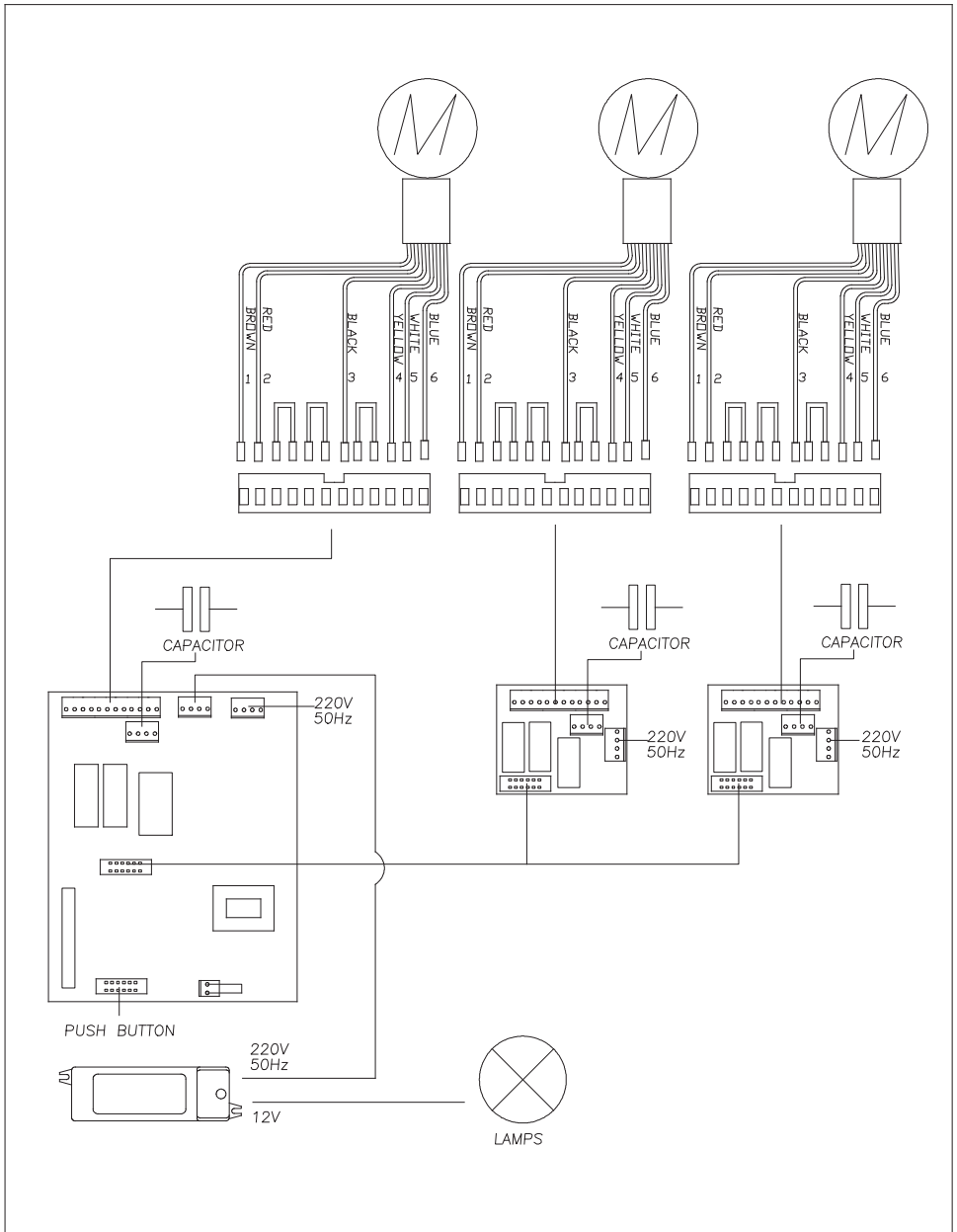

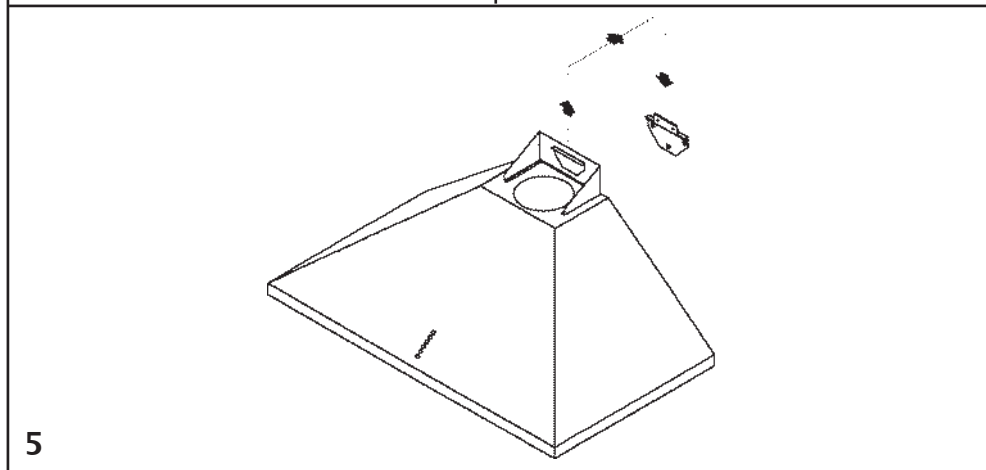
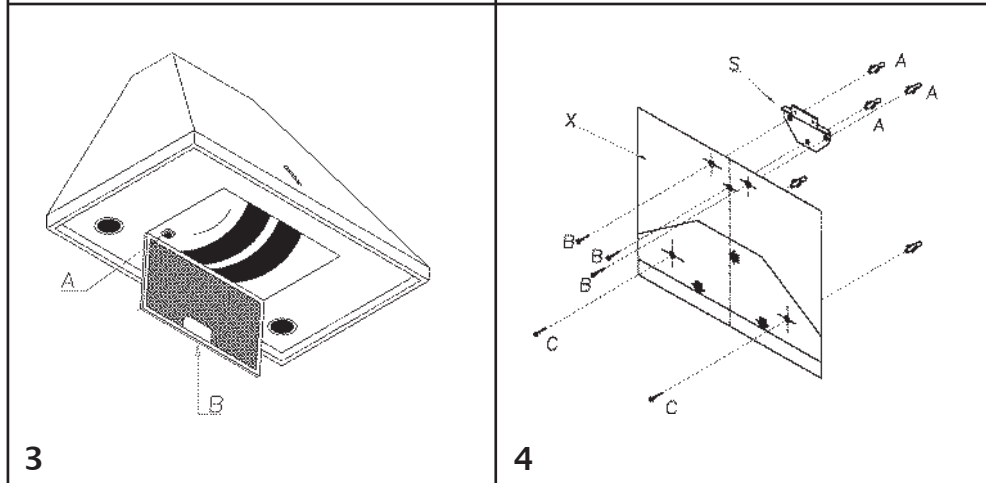
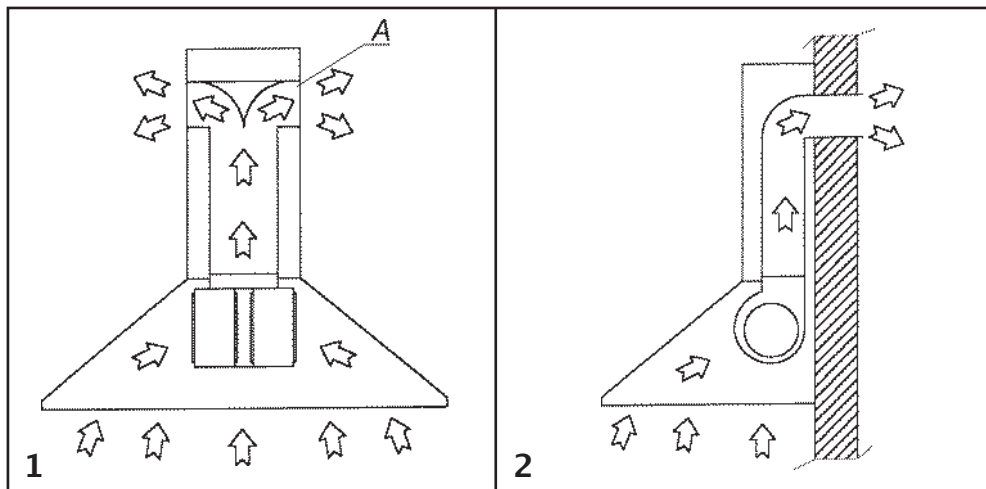

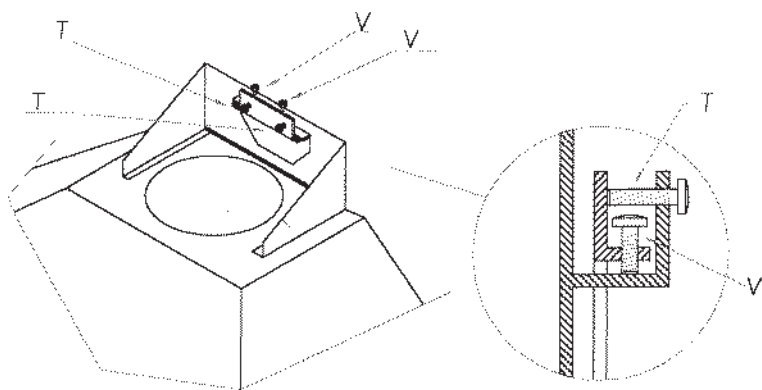

6

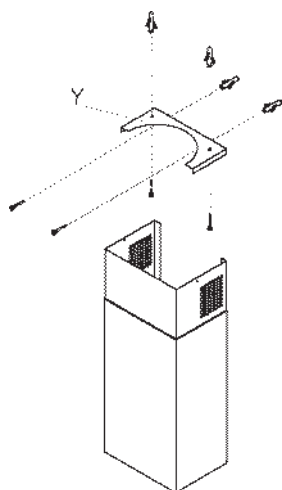

7

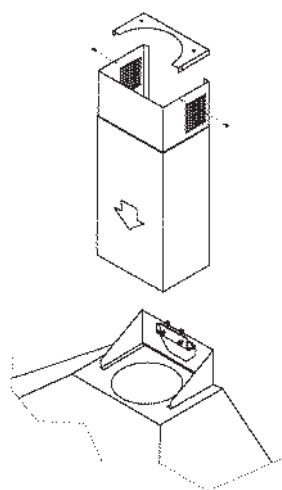

8

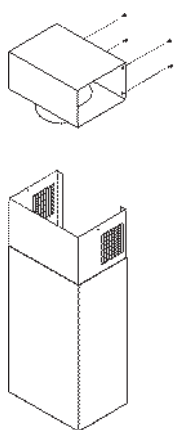

9

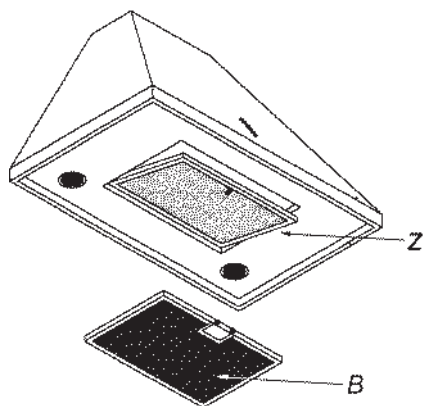

10

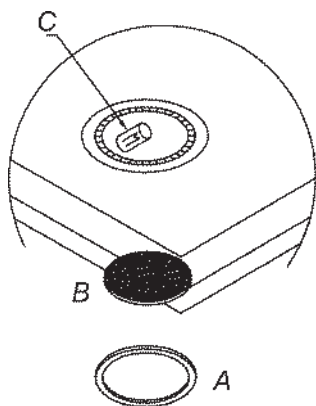

11

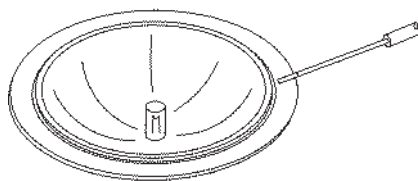

12

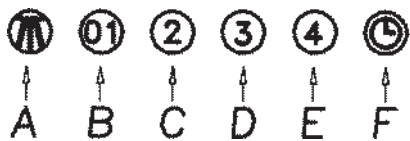

13

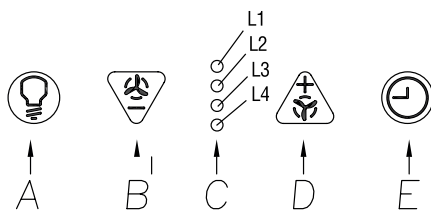

14

