

# 520mm ONBOARD UNDERMOUNT RANGEHOOD

SM923520



Rangehood type	Undermount
Control	Buttons
Speed settings	4
Ducting diameter	150mm
Extraction type	Onboard motor
Motor	Single Motor
Extraction	800m <sup>3</sup> /h
Filter	18/10 grade stainless steel baffle filter
Noise level	45dB (min) to 70dB (max)
Lighting	2 x spot lights
Induction Countdown Control	No
Electrical requirement	10A
Dimensions (mm)	W520 x D290 x H270
Cut-out dimensions (mm)	W505 x D270
Warranty	3 years (6 years when Sirius ducting is used)



**SINGLE MOTOR**



**18/10 GRADE STAINLESS BAFFLE FILTERS**



**800m<sup>3</sup>/h AIRFLOW**

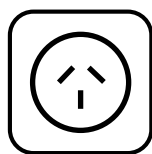

**10AMP GPO REQUIRED**



**2 x SPOT LIGHTS**



**HANDCRAFTED IN ITALY**

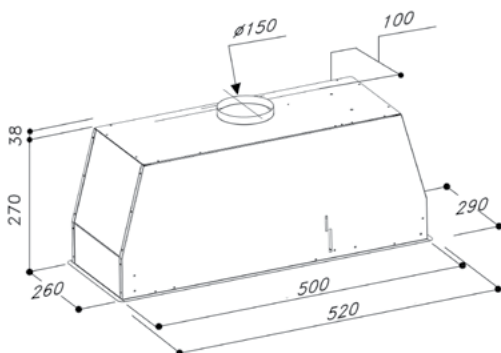

\*Product dimension includes trim

**Note: Need to allow 5mm extra for ease of installation**

## Ducting options

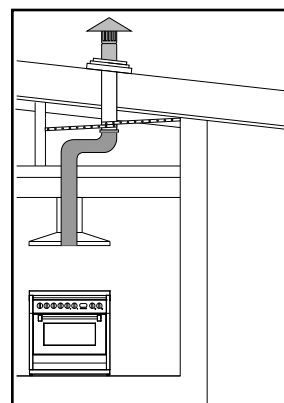

Roof ducted

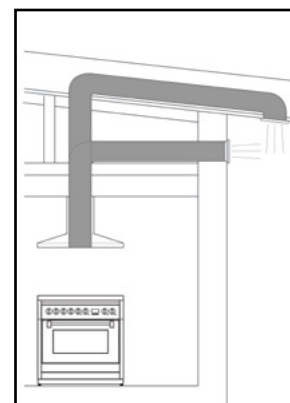

Eave or Wall ducted

- Use semi-rigid or rigid ducting, not fully flexible foil ducting.
- Fewer bends means a quieter and more powerful extraction.
- Extra 3 years warranty when Sirius ducting is used (total 6 years).
- See [support page](#) on Sirius website for installation videos and FAQs.

WARNING: technical specifications and product sizes can be varied by the manufacturer, without notice. Cut outs for appliances should only be by physical product measurements. The above information is indicative only.

Distributed by Arisit Pty Ltd

40-50 Mark Anthony Drive, Dandenong South VIC 3175

Ph: 1300 762 219

Fax: 03 9768 0838

Website: [www.arisit.com](http://www.arisit.com)

[www.siriusbrand.com](http://www.siriusbrand.com)