

850mm ONBOARD UNDERMOUNT RANGEHOOD

SM923L850



Rangehood type	Undermount
Control	Buttons
Speed settings	4
Ducting diameter	150mm
Extraction type	Onboard motor
Motor	Single Motor
Extraction	800m ³ /h
Filter	18/10 grade stainless steel baffle filter
Noise level	45dB (min) to 70dB (max)
Lighting	Strip LED
Induction Countdown Control	No
Electrical requirement	10A
Dimensions (mm)	W850 x D290 x H270
Cut-out dimensions (mm)	W835 x D270
Warranty	3 years (6 years when Sirius ducting is used)



SINGLE MOTOR



18/10 GRADE STAINLESS BAFFLE FILTERS



800m³/h AIRFLOW



10AMP GPO REQUIRED



STRIP LED



HANDCRAFTED IN ITALY

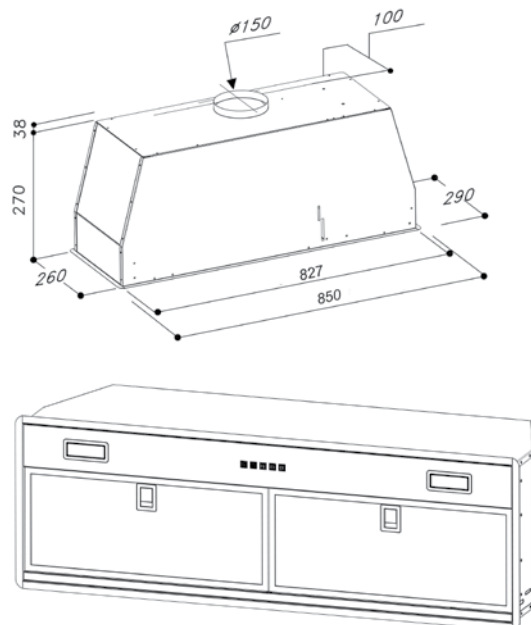

*Product dimension includes trim

Note: Need to allow 5mm extra for ease of installation

Ducting options

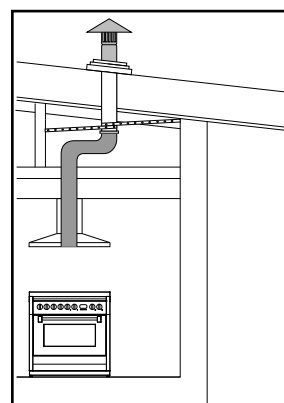

Roof ducted

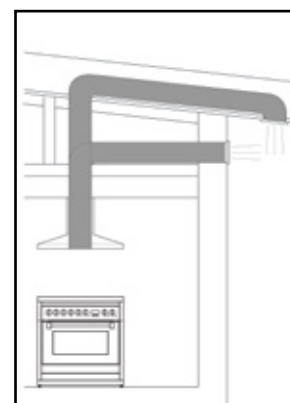

Eave or Wall ducted

- Use semi-rigid or rigid ducting, not fully flexible foil ducting.
- Fewer bends means a quieter and more powerful extraction.
- Extra 3 years warranty when Sirius ducting is used (total 6 years).
- See [support page](#) on Sirius website for installation videos and FAQs.

WARNING: technical specifications and product sizes can be varied by the manufacturer, without notice. Cut outs for appliances should only be by physical product measurements. The above information is indicative only.

Distributed by Arisit Pty Ltd

40-50 Mark Anthony Drive, Dandenong South VIC 3175

Ph: 1300 762 219

Fax: 03 9768 0838

Website: www.arisit.com

www.siriusbrand.com