

850mm ONBOARD UNDERMOUNT RANGEHOOD - BLACK GLASS FINISH

SM927EL850

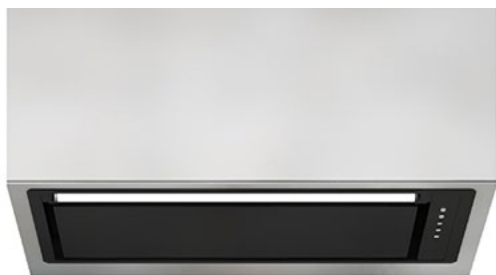

Rangehood type	Undermount
Control	Button
Speed settings	4
Ducting diameter	150mm
Extraction type	Onboard motor
Motor	Single aluminium motor
Extraction	800m ³ /h
Filter	Aluminium
Lighting	6.5W LED strip
Induction Countdown Control	No
Dimensions (mm)	W850 x D290 x H308
Cut-out dimensions (mm)	W835 x D265
Warranty	3 years (6 years when Sirius ducting is used)



SINGLE MOTOR

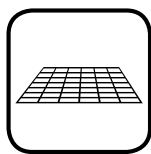

ALUMINIUM FILTERS

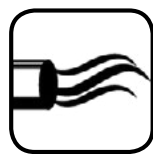

800m³/h AIRFLOW

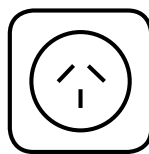

10AMP GPO REQUIRED



6.5W LED STRIP



HANDCRAFTED IN ITALY

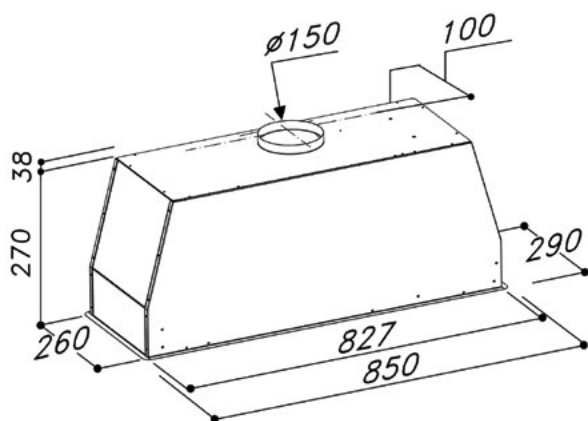

*Product dimension includes trim

Ducting options

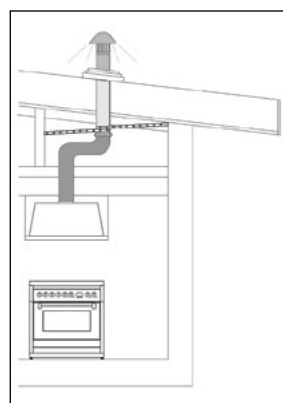

Roof ducted

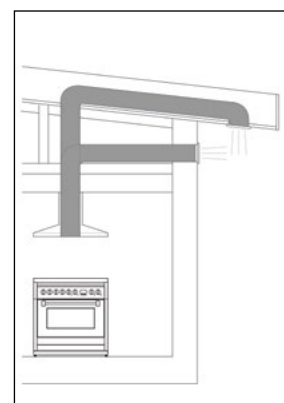

Eave or Wall ducted

- Use semi-rigid or rigid ducting, not fully flexible foil ducting.
- Fewer bends means a quieter and more powerful extraction.
- Extra 3 years warranty when Sirius ducting is used (total 6 years).
- See [support page](#) on Sirius website for installation videos and FAQs.

WARNING: technical specifications and product sizes can be varied by the manufacturer, without notice. Cut outs for appliances should only be by physical product measurements. The above information is indicative only.

Distributed by Arisit Pty Ltd

40-50 Mark Anthony Drive, Dandenong South VIC 3175

Ph: 1300 762 219

Fax: 03 9768 0838

Website: www.arisit.com

www.siriusbrand.com