



**Sirius**

A U S T R A L I A

**Alfresco Rangehoods**

**6** Year Warranty  
when Sirius ducting is used.

[www.siriusbrand.com](http://www.siriusbrand.com)



## SL80FRESCO900

900mm Outdoor Rangehood (Marine grade)



TWIN MOTOR



25mm BAFFLE FILTERS



2000m<sup>3</sup>/h AIRFLOW



10 MINUTE RUN-ON TIMER



LED LIGHTING



HANDCRAFTED IN ITALY

**Size:** 900mm wide

**Airflow:** 2000m<sup>3</sup>/h

**Motor:** Twin Aluminium

**Ducting:** 200mm

**Noise:** 66 dBA

**Warranty:** 3 years (6 years when Sirius ducting is used)



## SL80BBQ1200M

1200mm Outdoor Rangehood (Marine grade)



TWIN MOTOR



25mm BAFFLE FILTERS



2000m<sup>3</sup>/h AIRFLOW



10 MINUTE RUN-ON TIMER



LED LIGHTING



HANDCRAFTED IN ITALY

**Size:** 1200mm wide

**Airflow:** 2000m<sup>3</sup>/h

**Motor:** Twin Aluminium

**Ducting:** 200mm

**Noise:** 66 dBA

**Warranty:** 3 years (6 years when Sirius ducting is used)



## SL80BBQ1200B

1200mm Outdoor Rangehood (Black finish)



TWIN MOTOR



25mm BAFFLE FILTERS



2000m<sup>3</sup>/h AIRFLOW



10 MINUTE RUN-ON TIMER



LED LIGHTING



HANDCRAFTED IN ITALY

**Size:** 1200mm wide

**Airflow:** 2000m<sup>3</sup>/h

**Motor:** Twin Aluminium

**Ducting:** 200mm

**Noise:** 66 dBA

**Warranty:** 3 years (6 years when Sirius ducting is used)



## SL83BBQ1200M

1200mm Outdoor Rangehood (Marine grade)



TWIN MOTOR



25mm BAFFLE FILTERS



2400m<sup>3</sup>/h AIRFLOW



REMOTE CONTROL



LED LIGHTING



HANDCRAFTED IN ITALY

**Size:** 1200mm wide

**Airflow:** 2400m<sup>3</sup>/h

**Motor:** Twin Aluminium

**Ducting:** 200mm

**Noise:** 64 dBA

**Warranty:** 3 years (6 years when Sirius ducting is used)



### SL83FRESCO1500

1500mm Outdoor Rangehood (Marine grade)

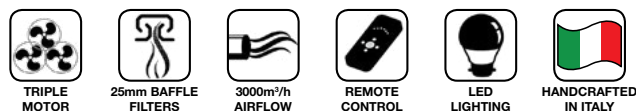

- Size:** 1500mm wide
- Airflow:** 3000m<sup>3</sup>/h
- Motor:** Triple Aluminium
- Ducting:** 300mm, or 3 x 150mm outlets
- Noise:** 68 dBA
- Warranty:** 3 years (6 years when Sirius ducting is used)



### SIL25FRESCO1200 with Remote Control

1200mm Outdoor Island Hood (Marine grade)

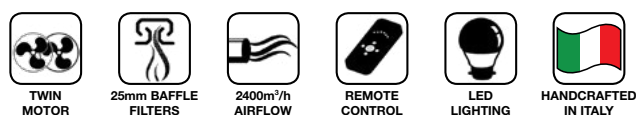

- Size:** 1200mm wide
- Airflow:** 2400m<sup>3</sup>/h
- Motor:** Twin Aluminium
- Ducting:** 200mm
- Noise:** 64 dBA
- Warranty:** 3 years (6 years when Sirius ducting is used)

## EXTERNAL MOTOR RANGE



### SLEM80BBQ1200

1200mm Outdoor Rangehood (Marine grade)



- Size:** 1200mm wide
- Airflow:** Variable based on SEM motor
- Motor:** Off Board - SEM7 or SEM8
- Ducting:** 200mm
- Noise:** Variable based on SEM motor and installation
- Warranty:** 3 years (6 years when Sirius ducting is used)



### SLEM83BBQ1200

1200mm Outdoor Rangehood (Marine grade)

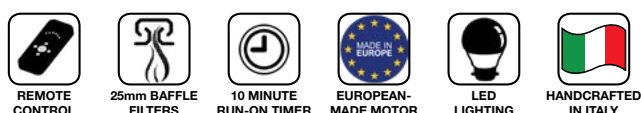

- Size:** 1200mm wide
- Airflow:** Variable based on SEM motor
- Motor:** Off Board - SEM7 or SEM8
- Ducting:** 200mm
- Noise:** Variable based on SEM motor and installation
- Warranty:** 3 years (6 years when Sirius ducting is used)



## Internal Motors – Inside the house

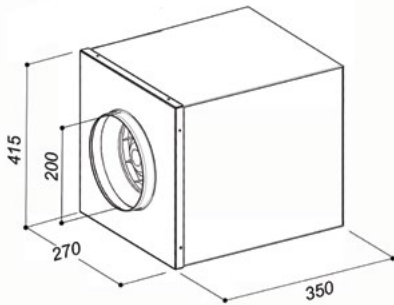

**SEM8**

Off board motor is located inside the house between the rangehood and final outlet

- 200mm Ducting Only
- Motor: 1650 m<sup>3</sup>/h extraction rate
- Aluminium die-cast motor housing
- Absorption: 265 W
- Pressure: 480 Pa
- Noise Level: 65 dBA

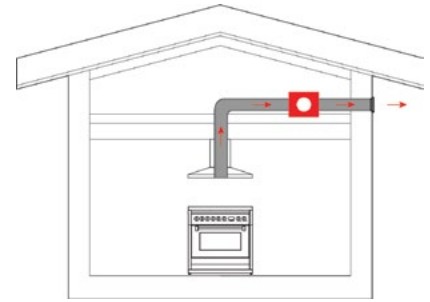

Shown with wall vent.  
Also available in roof or eave vent.

## External Motors – Outside the house

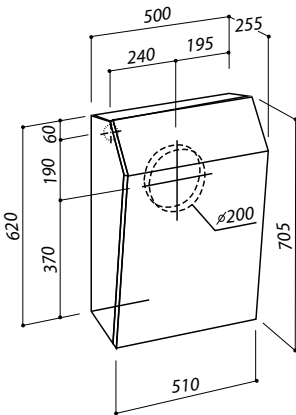

**SEM7XS316**

Wall Mounted Under Eave

- 200mm Ducting Only
- XS316 Marine Grade
- Motor: 2300 m<sup>3</sup>/h extraction rate
- Aluminium die-cast motor housing
- Absorption: 265 W
- Pressure: 480 Pa
- Noise Level: 68 dBA

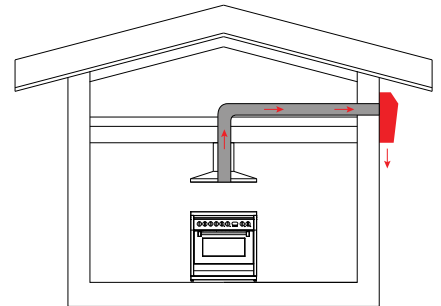

## Select Sirius Ducting for your 6 year warranty.



EASY-ROOF KIT



EASY-EAVE KIT



EASY-WALL KIT

The Sirius Alfresco range uses 200mm ducting. See website for kit details and ducting options.

**ARISIT PTY LIMITED** (Australia)  
ABN 23 091 515 294

40-50 Mark Anthony Drive  
Dandenong South VIC 3175  
P: Sales & Service: 1300 762 219  
F: Sales & Service: (03) 9768 0838  
E: arisit@arisit.com

**ARISIT PTY LIMITED** (New Zealand)  
1A Howe Street Newton, Auckland 1145  
PO Box 68-140 Newton, Auckland 1145  
P: (09) 306 1020 - Fax: (09) 302 0077  
E: sales2@aristonappliances.co.nz

[www.arisit.com](http://www.arisit.com)

[www.arisitwarranties.com.au](http://www.arisitwarranties.com.au)

[www.siriusbrand.com](http://www.siriusbrand.com)

**6 Year Warranty**

when Sirius ducting is used.

Full replacement warranty on parts and labour. Check website for T&Cs.

Sirius Hoods and ducting products are only available from our select group of Sirius Professional Stockists nationwide. For the latest list of Sirius Stockists near you, please refer to [www.siriusbrand.com](http://www.siriusbrand.com)

All efforts have been made to ensure that the information provided in this brochure is correct at the time of printing. Due to continuous product improvement and ongoing development, Sirius reserves the right to make changes to the products and technical data without prior notice. Some products appearing in this brochure may be for illustrative purposes only. Diagrams are indicative measures only. Prior to commencing cabinetry cutouts the operating/installation instructions accompanying the product must be referred to at [www.siriusbrand.com](http://www.siriusbrand.com)